

MEGALINEAR

HAJTASTECHNIKA  hu



MEGADYNE

INTRODUCTION TO OPEN-END BELTS

Megadyne started manufacturing moulded transmission belts in 1957 and extruding open ended belts in 1975. Megalineer open length belts are manufactured in thermoplastic polyurethane, that gives superior wear and abrasion resistance. Various types of steel cord, offer good running characteristics, even under high tractive loads. Advanced production processes, allow the ability to engineer bespoke technical design solutions to meet market demands. By selecting from a range of components and materials, Megalineer belts can be manufactured to perform in even the most demanding applications. **MEGALINEAR** open-end belts are particularly suited where the most precise accuracy of position, low noise and long maintenance free cycles are the key requirements.

Megadyne has expanded the Megalineer range to include:

- **MEGALINEAR QST**
- **MEGALINEAR GW**
- **MEGALINEAR FC - FCM - XMD**
- **MEGALINEAR MEGAC4T™**

Uniquely designed to reduce the noise levels, generated during high speed operations, **MEGALINEAR QST** is completely self-tracking without the need for flanged pulleys. The nylon faced helical offset teeth design, provides a high torque capacity.

For heavier applications, Megadyne have introduced the **MEGALINEAR GW**, a high performance thermoplastic polyurethane belt. Superior load capacities can be achieved due to the high shear strength of the tooth design, coupled with high tension, steel zinc coated cords, MEGALINEAR GW guarantees a greater transmittable power under continuous high loads.

MEGALINEAR FC is a new range of belts of the MEGALINEAR family. Specifically introduced for the food processing industry, MEGALINEAR FC is manufactured with Food Contact approved materials, according to European regulations EU 1935/2004, EU 10/2011 and EU 174/2015. It's manufactured in T5/T10 pitches without nose gap between the teeth and available with a variety of backing profiles, for all kinds of conveying and processing applications. These advanced FDA synchronous belts have excellent resistance to chemicals and corrosion, certified for wet and dry food contact. The homogenous belt design ensures a significantly greater service life, with a high level of hygienic integrity.

On request and with minimum quantity, it's possible to produce **MEGALINEAR FCM**, made in sky blue colour (RAL 5012) and certified for direct contact with dry and wet food.

Both MEGALINEAR FC AND FCM can be made with a special Metal and X-Ray detectable compound. **MEGALINEAR XMD** decreases the risk of contamination from belt fragments protecting Consumer Safety.

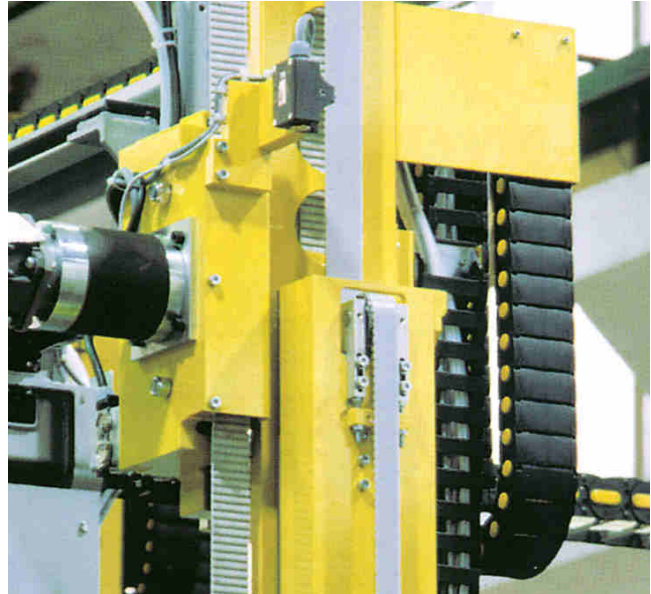

INTRODUCTION TO OPEN-END BELTS



MEGAC4T

Megalinear **A**daptable **C**leats For **T**ransport - is the most versatile belt ever!

Its design with quick and easy interchangeable profiles means you can use the same belt for a wide variety of applications, transporting goods of different shapes on a single transport system with a minimum of downtime!

Thanks to their features, Megalineer belts can be successfully used in a wide range of applications such as:

- automatic sliding doors and garage opening system
- elevators
- automated handling devices
- linear drivers
- positioning system
- conveyors
- wood industry
- textile machine
- serigraphic industry
- glass industry
- stone and marble industry
- packaging industry
- robot systems
- tobacco industry
- paper and carton industry
- chemist and pharmaceutical industry
- Food industry

Megadyne has developed a very wide range of solutions with numerous tooth designs, tensile members and compound, suitable for all applications.

STANDARD RANGE



MXL • XL • L • H • XH



T2,5 • T5* • TT5 • T10* • T20



AT3 • AT5 • AT10 • MEGAC4T™ AT10 • AT20



MTD3 • MTD5 • MTD8 • MTD14



RPP5 • RPP8 • RPP14 • RPP14XHP



STD5 • STD8



HG • TG5 • TG10K6 • TG10K13 • TG20 • ATG5 • ATG10 • ATG20



QST5 • QST8 • QST14



GW14 • GW20



P1 • P2 • P3 • P4

* Available in Food Contact (FC) / X-Ray and Metal detectable (XMD) versions.

CLASSIFICATIONS

CLASSIFICATIONS

Megalinear Timing Belts are manufactured in thermoplastic polyurethane, with single parallel steel cords. This type of belts, developed by our Research & Development, offers good running characteristics and high traction loads. They are especially suited for power transmission and conveying with high loads and speeds. The addition of a nylon coating on the teeth during production enhances the running properties for specific applications and reduces the noise due to a lower frictional coefficient. An extra thickness of special coating is also possible on the back of the belt offering extra protection against aggressive or heavy products.

1. The body of the belts is white thermoplastic polyurethane 92 ShA, characterized by high levels of wear resistance even in the presence of shock and surge loading.
2. High strength S and Z parallel zinked steel tension members allow high breaking load and extremely low elongation. The combination of these high grade materials improves belt performances which can be summarised as follows:
 - exceptional resistance to abrasion and tooth shear
 - low coefficient of friction
 - high flexibility
 - ozone and temperature resistance (-25 °C / +80 °C)
 - oil, grease and gasoline resistance

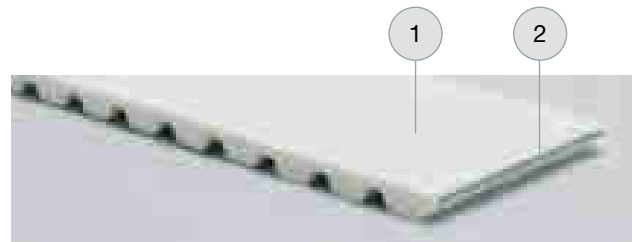

MECHANICAL AND CHEMICAL CHARACTERISTICS

- Constant dimensions
- Noiseless
- Free maintenance
- High flexibility
- High resistance steel traction cords, with little stretching and top flexibility
- Linear speeds up to 20 m/s
- Low pretension
- Constant length
- High abrasion resistance
- Ageing, Hydrolysis, Ozone resistant
- Working temperature -25 °C / +80 °C
- High resistance to Oils, Greases and Gasoline
- Fairly Acid-proof and Alkali-proof

BODY

Megalinear belts are manufactured with white thermoplastic Polyurethane 92 ShA as standard.

Special compounds (different hardnesses, special properties) are available on request. Special compound and cords have to be tested and homologated on the application. Megadyne is not responsible for wrong functioning of special products. Here under some PU characteristics:

Water	No problem in normal or sea clean water, at room temperature. Over 60 °C there is a fast decrement of breaking strength.
Acids	In acid diluted proportions, at room temperature, this PU is moderately attacked. In high concentration acid solutions, this PU has a very short lifespan. Over 50 °C, acids are always dangerous for Thermoplastic PU.
Alkalis	In alkalis diluted proportions, at room temperature, this PU is moderately attacked. In high concentration alkaline solutions, this PU has a very short lifespan. Over 50 °C, alkalis are always dangerous for Thermoplastic PU.
Solvents	Thermoplastic PU is insoluble in the greater part of solvents. Only the very polar solvents (same as tetrahydrofuran, dimethylformamide, n-methylpyrrolidone) can dissolve or tight damage PU. The Esters or the Ketons (same as ethyl acetate or methylethylketene) can usually produce a bulge, decreasing mechanical characteristics. The Hydrocarbons aromatic and the Hydrocarbons aliphatic produce very high bulge. All the effects increase by increasing temperature.
Oils	PU has a high resistance to mineral pure oils (lubrificants, engine oils, combustible oils). Usually, high performance syntetic oils, due to special additives contained, can be incompatible with Thermoplastic PU, especially at high temperature.

Greases	PU has a high resistance to mineral pure greases (lubricants greases). Usually, high performance syntetic greases, due to special additives contained, can be incompatible with Thermoplastic PU, especially at high temperature.
Fuels	Good resistance to petrols without Alcohols. In presence of Alcohols, Thermoplastic PU can suffer deterioration. Fuels including Aromatiche stuffs can produce reversible bulges.
Microorganisms	In presence of grime, containing humidity, Microorganisms can develop. In case that Microbic attack can produce danger, you have to use a special kind of PU.
Weather agents	Good resistance to atmospheric agents. White colour can change to light yellow under long UV exposure. In any case this hasn't influence on mechanical resistance.

CORDS

Standard cord	Megalinear is manufactured with S and Z parallel zinked steel cords as standard.
Kevlar	Kevlar tension cords are suggested for: <ul style="list-style-type: none"> • Non magnetic, for use in drives with metal detectors • Widely used in the food industry • Applications in damp evonement must be avoided Kevlar cord belts have a lower dimentional stabiliy compared to stell cord belts. Length and tollerance may change.
HP	High Performance cords have 25% more strength capacity than standard cords. They are recommended for high repeatability applications.
HF	High Flexibility cords can accept smaller pulley and idler diameters than standard cords. They are suitable for multi-shaft drives with severe reverse bending.
HPF	High Performance and Flexibility cords have 25% more strength capacity like the HP cords, but they are more flexible than the HP cords. They are suggested for high performance and multi-shaft drives.
Stainless steel	Stainless steel cords have 25% less strength capacity than standard cords. They are recommended for water applications.

COATING
Megalinear can be manufactured with special coating on the teeth or on the back. Please check on page 120 and 121.

IDENTIFICATION CODE

Using the information in the table below, it is possible to identify the correct belt for every application. The code is composed of letters and numbers as the following example::

1	2	3	4	5	6					
J	+	50	+	AT	+	10	+	10000	+	SPECIAL MANUFACTURES

- 1) **J** joined belt.
- 2) **ML** Megalinear belt open-end.
- 3) **50** this number indicates the width of requested belt. The value is in mm for a belt with a pitch in mm, and in inches for a belt with a pitch in inches.
- 4) **AT** this code composed by letters indicates the selection of profile.
- 5) **10** this number indicates the standard pitch of the belt. It is expressed in mm.
- 6) **10000** the last number indicates the length of the belt always in mm regardless of pitch.
- 6) **SPECIAL MANUFACTURES:**
 - special cords as Kevlar or HP or HF or HPF or stainless steel
 - special compound as different hardness 85 ShA or different colours (black - red - yellow - blue)
 - extra coating NFT or NFB or AVAFC or Tenax or Linatex or Honey comb or PU black cellulose or PU yellow or Neoprene rubber.

TECHNICAL CALCULATION

LINEAR MOTION BELT

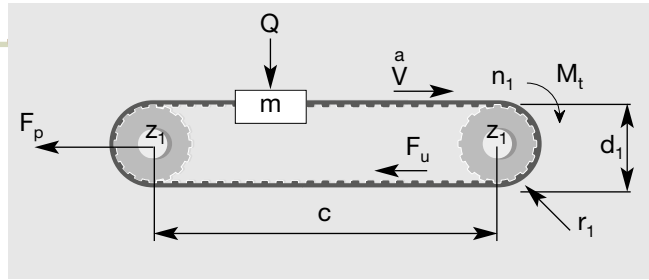

OMEGA LINEAR MOTION BELT

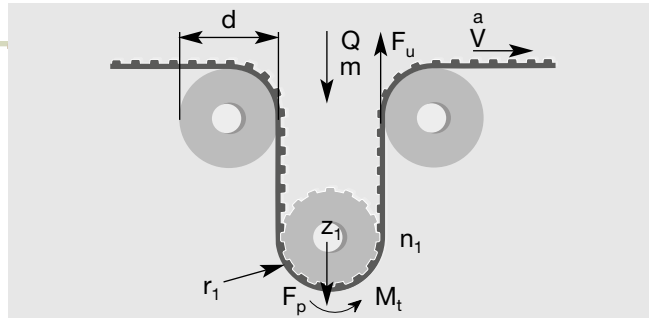

CONVEYOR BELT

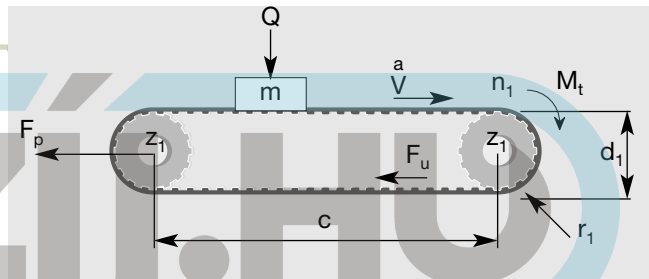

The following pages contain data, formulae and tables that are required to design a new belt drive. For critical and difficult drives, it is recommended that you contact our Application Department for advice.

Symbol	Unit	Definition	Symbol	Unit	Definition
a	m/s ²	acceleration	g	m/s ²	gravity (9,81)
b	mm	belt width	μ	–	friction coefficient
C	–	safety factor	m	Kg	conveyed mass
Δl/100	%	elongation	M_t	Nm	drive torque
d	mm	idler pitch diameters	n₁	1/min	revs/min (RPM) of drive sprocket 1
d₁	mm	sprocket pitch diameter	P	KW	drive power
F_p	N	pretension	Q	N	force exerted by mass (m)
F_u	N	peripheral force	V	m/s	belt speed
F_{p spec}	N/cm	transmittable force per tooth per unit width	Z₁		number of teeth of sprocket
MTL	N	max traction load	Z_m		number of teeth in mesh on driver sprocket (12)
BS	N	breaking strength	Z_L		number of teeth of large pulley
c	mm	centre distance	Z_s		number of teeth of small pulley
			p		belt pitch

Max traction load is maximum acceptable traction on cords.
 Breaking strength is necessary load to break belt cords.
 Elongation is belt elongation under load.

USEFUL FORMULAE AND CONVERSION FACTORS

$$V = \frac{d_1 \cdot n_1}{19100} \quad n_1 = \frac{V \cdot 19100}{d_1} \quad d_1 = \frac{V \cdot 19100}{n_1} \quad Q = m \cdot g$$

$$P = \frac{M_t \cdot n_1}{9550} \quad M_t = \frac{9550 \cdot P}{n_1} \quad M_t = \frac{F_u \cdot d_1}{2000}$$

CHOICE OF BELT PITCH AND SPROCKETS

For optimum belt pitch see tables on page 10.

For optimum choice of sprocket size, it is desirable to have as near to 12 teeth in mesh as possible.

Knowing mass	→ For horizontal & conveying drives	$F_u = (m \cdot a) + (m \cdot g \cdot \mu)$
	(Note: values of μ can be found in table 1 on page 11).	
	→ For vertical drives	$F_u = (m \cdot a) + (m \cdot g)$
Knowing drive torque		$F_u = 2000 M_t / d_1$
Knowing drive power		$F_u = 19.1 \cdot 10^6 \cdot P / (d_1 \cdot n_1)$

BELT WIDTH AND PROFILE ESTIMATION

The belt width b should be calculated using the following formula

$$b = (F_u \cdot c_s \cdot 10) / (F_{p \text{ spec}} \cdot Z_m)$$

C_s = safety factor from page 11 table 4
 F_u = from above calculation
 Z_m = number of teeth in mesh on driver sprocket
 $Z_m = [0,5 - \frac{4 \cdot p}{79 \cdot c} (Z_L - Z_s)] \cdot Z_s$
 = (if calculated $Z_m > 12$ for an open-end application use $Z_m = 12$)
 = (if calculated $Z_m > 6$ for a joined application use $Z_m = 6$)
 $F_{p \text{ spec}}$ = transmittable force per tooth per unit width (see table on belt data pages)

PRE-TENSIONING

The suggested installation tension:

$$F_p = 2 \cdot F_u \text{ for linear and omega linear movement applications}$$

$$F_p = F_u \text{ for conveyor applications}$$

CORD CHECK

The maximum allowable tensile load of the belt pitch/width combination selected (see tables on belt data pages):

$$\text{max traction load of choosen belt} > \frac{F_p}{2} + (F_u \cdot C_s)$$

SPROCKET AND IDLER DIAMETER CHECK

Ensure that all selected pulley and idler diameters are equal to or greater than the minimum values specified in corresponding belt data page.

ELONGATION

When the belt is operating there will be an elongation proportional to max traction load:

$$\Delta l / l_0 = (F_u \cdot 4) / \text{max traction load}$$

LINEAR MOTION CALCULATION EXAMPLE (OPEN-END BELT)

MACHINE DATA

$C = 2.000 \text{ mm}$
 $d_1 = 76 \text{ mm}$
 $n_1 = 300 \text{ RPM}$
 $P = 1,8 \text{ KW}$
 low fluctuating load

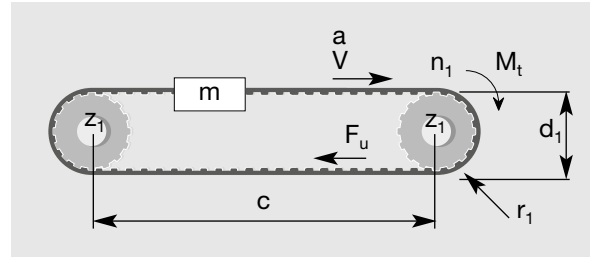

CHOICE OF BELT PITCH AND SPROCKETS

According to the belt pitch selection table n.1 on page 10 considering the values of P and n_1 , we select RPP8 belt. Then we consider the pulley diameter nearest to the requested value and the corresponding n . of teeth (see technical information on page 65). Therefore $Z_1 = 30$ teeth (with a pitch diameter of 76,4 mm).

CALCULATION OF THE EFFECTIVE TENSION

Since the drive power is known, F_u can be calculated

$$F_u = \frac{19,1 \cdot 10^6 \cdot P}{d_1 \cdot n_1} = \frac{19,1 \cdot 10^6 \cdot 1,8}{76,4 \cdot 300} = 1500 \text{ N}$$

DETERMINATION OF THE BELT WIDTH

$$b = \frac{F_u \cdot C_s \cdot 10}{F_{p \text{ spec}} \cdot Z_m}$$

$$b = \frac{1500 \cdot 1,4 \cdot 10}{62 \cdot 12} = 28,2 \text{ mm}$$

$F_u =$ from before (1500 N)
 $C_s =$ from page 11 table 4, for low fluctuating load $C_s = 1,4$
 $Z_m =$ given that driver pulley has 30 teeth and n . of teeth in mesh = 15 but max Z_m is 12, then $Z_m = 12$
 $n_1 = 300 \text{ RPM}$ (given)
 $F_{p \text{ spec}} = 62 \text{ N / cm}$ (refer page 64 at 300 RPM)

Since the next closest width is 30 mm: 30 RPP8 is chosen.

PRE-TENSIONING

$$F_p = 2 \cdot F_u \quad F_p = 3000 \text{ N}$$

CORD CHECK

From page 64, RPP8 pitch 30 mm wide: max traction load 4750 N

$$\text{max traction load} > \frac{F_p}{2} + (F_u \cdot C_s) \quad \frac{F_p}{2} + (F_u \cdot C_s) = 1500 + 1500 \cdot 1,4$$

4750 N > 3600 N selected belt is acceptable.

SPROCKET AND IDLER DIAMETER CHECK

Ensure that all selected pulley and idler diameters are greater than or equal the minimum values specified on page 65.

ELONGATION

$$\Delta l_{/00} = \frac{F_u \cdot 4}{\text{max traction load}} = \frac{1500 \cdot 4}{4750} = 1,26 \text{ mm/m}$$

In the dynamic situations you will have an elongation of 1,26 mm per meter of operating belt.

CONVEYOR BELT CALCULATION EXAMPLE (JOINED BELT)

MACHINE DATA

$C = 5.000 \text{ mm}$
 $d_1 = 100 \text{ mm}$
 $V = 0,5 \text{ m/s}$
 $a = 0,5 \text{ m/s}^2$
 Guide in nylon
 $Q = 4500 \text{ N}$
 low fluctuating load

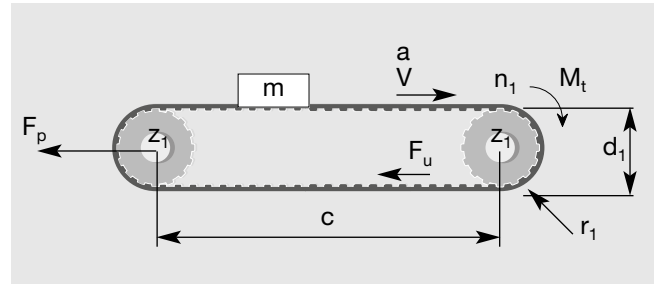

CALCULATION OF THE EFFECTIVE TENSION

Since the mass is known, F_u can be calculated $F_u = (m \cdot a) + (m \cdot g \cdot \mu)$ value of μ according to table 3 on page 11 = 0,35
 $F_u = (460 \cdot 0,5) + (460 \cdot 9,81 \cdot 0,35) = 1810 \text{ N}$
 $m = Q/g = 4500 / 9,81 = 460 \text{ kg}$

CHOICE OF BELT PITCH AND SPROCKETS

According to the belt selection table n. 2 on page 10, considering the values of F_u (for joined belts enter double of calculated F_u in table 2), we select T 10. Then we consider the pulley diameter nearest to the requested value and the corresponding n. of teeth (see technical information page 35). Therefore $Z_1 = 32$ teeth (with a pitch diameter of 101,86 mm).

DETERMINATION OF THE BELT WIDTH

$$b = \frac{F_u \cdot C_s \cdot 10}{F_{p \text{ spec}} \cdot Z_m}$$

$$b = \frac{1810 \cdot 1,4 \cdot 10}{45 \cdot 6} = 93,85 \text{ mm}$$

$F_u =$ from before (1810 N)
 $C_s =$ from page 11 table 4, for low fluctuating load $C_s = 1,4$
 $Z_m =$ given that driver pulley has 32 teeth and n. of teeth in mesh = 16 but max Z_m for joined belt is 6, hence, $Z_m = 6$
 $n_1 = (Vp \cdot 60.000) / (\pi \cdot d_1) = (0,5 \cdot 60.000) / (\pi \cdot 101,86)$ as $d_1 = 101,86$ from before = 94 RPM
 $F_{p \text{ spec}} = 45 \text{ N / cm}$ (refer page 34, at 100 RPM)

Since the next closest width is 100 mm: 100 T10 is chosen.

PRE-TENSIONING

$F_p = F_u$ so $F_p = 1810 \text{ N}$

CORD CHECK

From page 34, T10 pitch 100 mm wide joined: max traction load 5415 N

$$\text{max traction load} > F_p + (F_u \cdot C_s) \quad F_p + (F_u \cdot C_s) = 1810 + (1810 \cdot 1,4)$$

5415 N > 4344 N selected belt is acceptable.

SPROCKET AND IDLER DIAMETER CHECK

Checking technical data on page 35 for pulley and idlers, it can be seen that the drive has acceptable pulley diameters.

ELONGATION

$$\Delta l / l_0 = \frac{F_u \cdot 4}{\text{max traction load}} = \frac{1810 \cdot 4}{5415} = 1,33 \text{ mm/m}$$

In the dynamic situations you will have an elongation of 1,33 mm per meter of operating belt.

CALCULATION PARAMETERS

BELT PITCH SELECTION

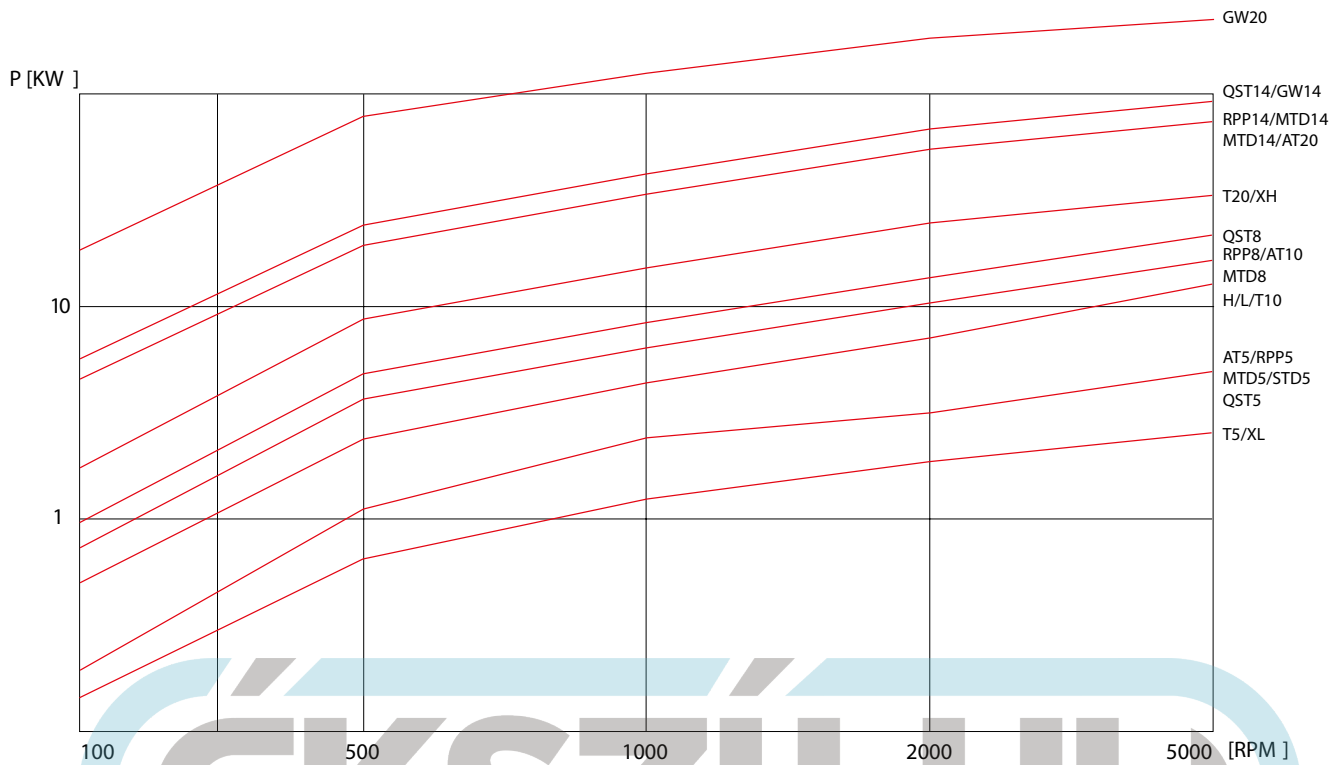

Table n. 1

BELT WIDTH SELECTION

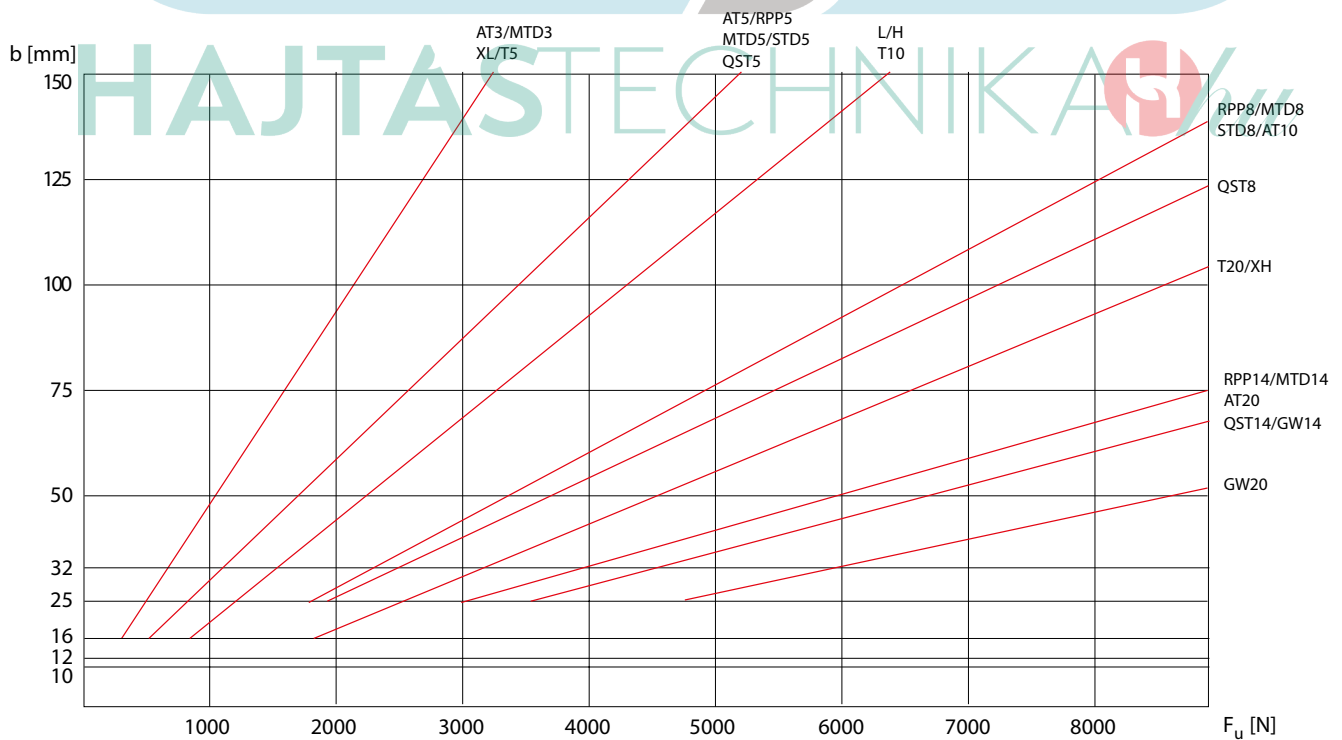

Table n. 2

Average values valid for standard steel cord. After belt selection, please check belt resistance on belt data page.

Table n. 3 - Friction coefficient

Sliding friction on dry surface	
Polyurethane / smooth steel	$\mu = 0,5$
Polyurethane / rough steel	$\mu = 0,7$
Polyurethane / abrasive steel	$\mu = 0,9$
Polyurethane NFT / smooth steel	$\mu = 0,25$
Polyurethane NFT / rough steel	$\mu = 0,35$
Polyurethane NFT / abrasive steel	$\mu = 0,6$
Polyurethane / nylon	$\mu = 0,35$
Polyurethane NFT / nylon	$\mu = 0,15$
Polyurethane / aluminium	$\mu = 0,8$
Polyurethane NFT / aluminium	$\mu = 0,45$
Rolling friction on dry surface	
Bearing	$\mu = 0,015$
Roller / PU Belt	$\mu = 0,03 / 0,06$
Bush	$\mu = 0,15$

Table n. 4 - Safety factor

The choice of the Safety factor's, depends on the operating conditions.
The following table shows the value to be used:

Steady Load	1	
Shock Load	Low	1,4
	Average	1,7
	High	2
Elevators, hoists	1,8	
Line shafts	1,6	
Paper machines:		
agitators, calenders, driers, winding frames,	1,6	
willows, Jordan machines, pumps, slicers, grinders	1,8	
Machines for pottery and earthenware:		
cutters, granulators,	1,7	
pulping machines	2,0	
Laundry machines: general	1,6	
extractors, washers	1,8	
Machines for rubber processing	1,8	
Woodworking machines:		
lathes, band saws, cutters,	1,7	
circular saws, planers, jointer	1,7	
Printing machinery:		
rotary, newspaper, linotype, cutters, folders, magazine	1,6	
Textile machines:		
warping machines, winders,	1,7	
spinners, twisting frames, looms	1,8	
Machines tools: drilling machines, lathes,		
tread cutting machines, gears cutters, boring machines	1,6	
millers, planers,	1,7	
grinding machines	1,7	
Conveyors:		
hoists, light package	1,3	
oven screw fleight	1,8	
apron bucket, elevator	1,8	
screw	1,8	
Brick machinery	1,8	

BELT INSTALLATION

A major difficulty installing transmission belt is to achieve correct belt tension. Lifetime of support bearings and transmission belts and therefore reliability of the complete system largely depends on an optimally adjusted belt tension. Pretension is the force needed to put tension into the system to avoid the belt jumping on the pulleys as in the example below:

Not correct belt installation

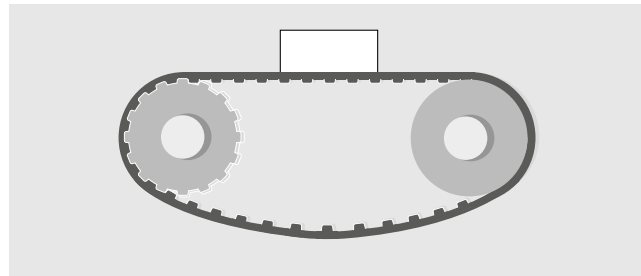

For a correct system installation, all applications with Megalineer belt can be summarised according following two sketches:

1) Linear and omega linear motion belt

2) Conveyor belt

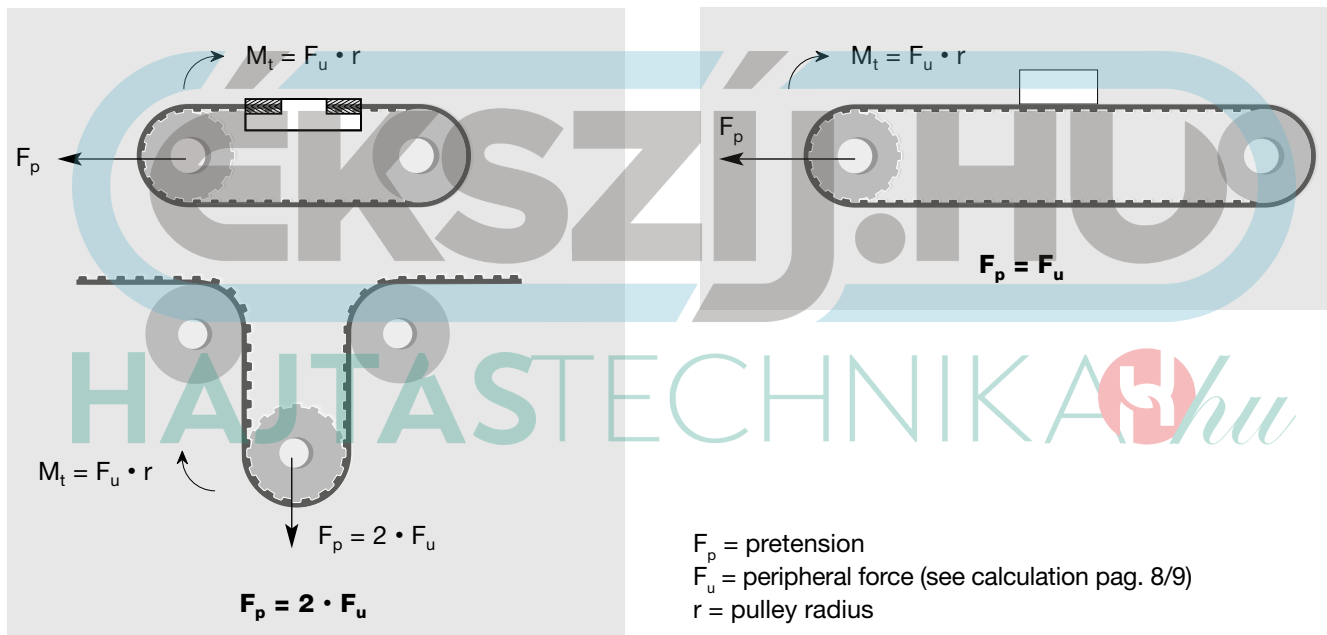

PROCEDURE TO MEASURE

The procedure to measure the tension of the belt is to use a Belt Tension Gauging Equipment. This device consists of a small sensing head which is held across the belt to be measured. The belt is then tapped to induce the belt to vibrate at its natural frequency. The vibrations are detected and the frequency of vibration is then displayed on the measuring unit. The relation between belt static tension (T_s) and frequency of vibration (f) may be calculated using the following formula:



$$f = \frac{1}{2t} \cdot \sqrt{\frac{T_s}{m}} \quad \text{or} \quad T_s = 4 \cdot m \cdot t^2 \cdot f^2$$

Where :

T_s = static tension (N)

f = Frequency of vibration in Hertz (Hz)

m = Belt mass per unit length (kg/m)

t = Free belt span length in meters (m)

BELT INSTALLATION

For a correct system functioning and to increase belt life, it is necessary a correct pulley installation: pulleys has to be parallel and aligned as shown in drawing 1 (correct configuration).

If pulleys are not parallel as in drawing 2, belt could fall during functioning and this can provoke damages to complete equipment.

To grant a correct belt running, α and Δx must be as smaller as possible. For more information, please contact our technical staff.

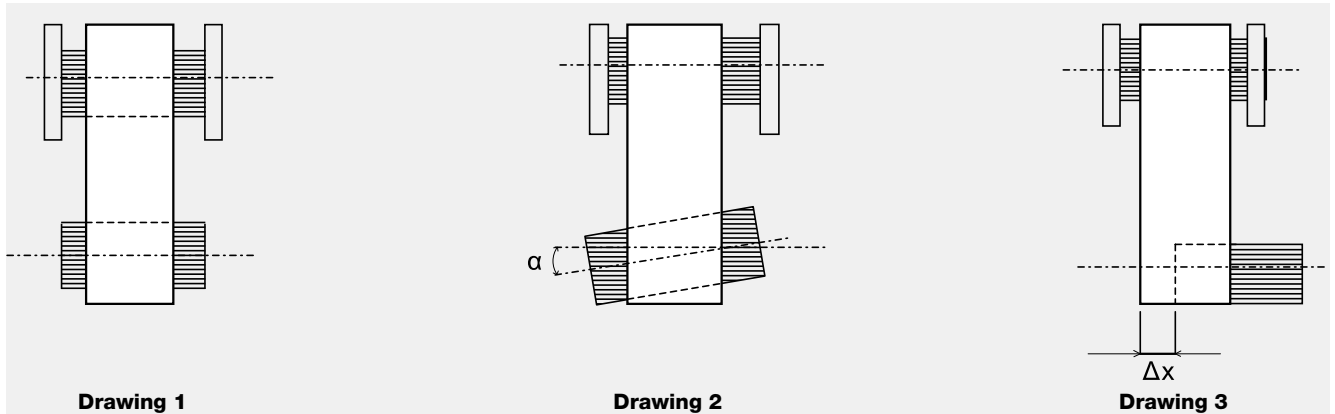

In omega application to grant good mesh between pulley and teeth and to respect belt flexibility avoiding excessive stress on cords, distance d (as drawing 4) has to be:

$d = 4 \cdot \text{belt width}$
Suggested angle 120°

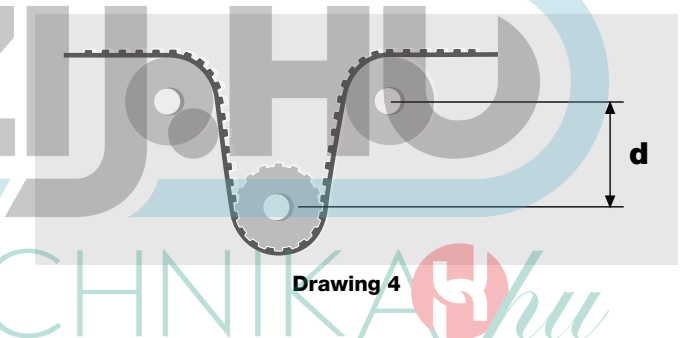

Moreover for a good drive work, it is suggested to check belt straightness as follows:

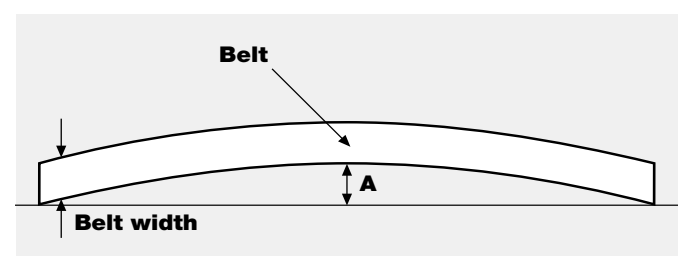

Belt width	Testing belt length	Maximum suggested bending (A)
Till to 20 mm	1 m	3 mm
Over 20 mm	2 m	4 mm

MEGALINEAR FLAT OPEN-END

BELT CHARACTERISTICS

	10 P1	20 P1	25 P2	50 P2	75 P2	100 P2
Weight (gr/m)	20	40	135	245	370	490
Polyurethane 92 ShA	blue	blue	white	white	white	white
Width tolerance(mm)	10 +/-0,5	20 +/-0,5	25 +/-0,5	50 +/-0,5	75 +/-0,5	100 +/-0,5
Thickness (mm)	1+/-0,1	1+/-0,1	2+/-0,2	2+/-0,2	2+/-0,2	2+/-0,2
Gap	Straight	Straight	Straight	Straight	Straight	Straight

	30 P3	60 P3	100 P3	120 P3	25 P4	50 P4	100 P4
Weight (gr/m)	213	426	710	852	220	445	890
Polyurethane 92 ShA	black	black	black	black	transparent	transparent	transparent
Width (mm)	30 +/-0,5	60 +/-0,5	100 +/-0,5	120 +/-0,5	25 +/-0,5	50 +/-0,5	100 +/-0,5
Thickness (mm)	3,2+/-0,2	3,2+/-0,2	3,2+/-0,2	3,2+/-0,2	4+0,4/-0	4+0,4/-0	4+0,4/-0
Gap	Helical	Helical	Helical	Helical	Straight	Straight	Straight

Standard back cover: **none**
 Standard tooth cover: **none**
 Standard cords: **S and Z torsion zinked steel**
 Standard roll length: **100 m**
 Belt options on request with minimum quantity:

- Nylon fabric back
- Nylon fabric teeth
- Antistatic nylon fabric
- No gap
- Silicon free compound
- Special thickness tolerances by grinding (suggested for applications with rolled belts)

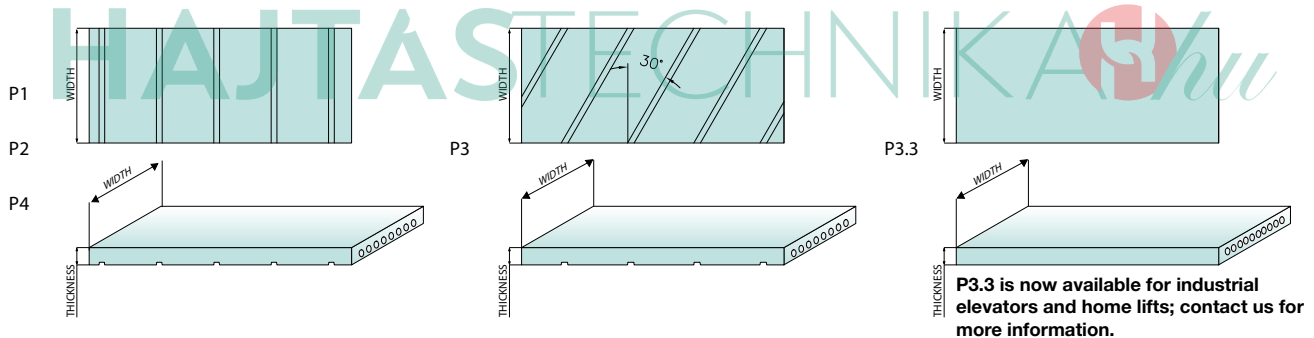

TRACTION RESISTANCE

	Belt width (mm)	10 P1	20 P1	25 P2	50 P2	75 P2	100 P2
Steel	Max Traction Load (N)	490	980	3800	8075	13000	17500
	Breaking Strength (N)	1965	3935	15200	32300	49400	66500
	Elongation at MTL (mm/m)	4	4	4	4	4	4
HP	Max Traction Load (N)	-	-	5190	11245	18210	24580
	Breaking Strength (N)	-	-	20760	44980	69200	93420
	Elongation at MTL (mm/m)	-	-	4	4	4	4

	Belt width (mm)	30 P3	60 P3	100 P3	120 P3	25 P4	50 P4	100 P4
Steel	Max Traction Load (N)	9120	19200	32000	42560	8000	16000	34525
	Breaking Strength (N)	36480	72960	121600	148960	32000	64000	131200
	Elongation at MTL (mm/m)	4	4	4	4	4	4	4

FLEXION RESISTANCE

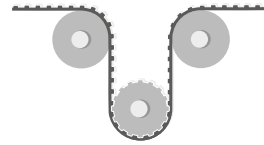
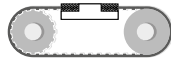

	Driver pulley min dia (mm)	Driver pulley min dia (mm)	Idler min dia (mm)
Standard steel cords P1	16	25	30
Standard steel cords P2	45	50	90
High Power cords P2	56	62	150
Standard steel cords P3	100	110	150
Standard steel cords P4	100	110	150

FIXING PLATES

DIMENSION OF THE FIXING PLATES

Belt type	Clamping plates dimensions					Suggested clamping plate width W (mm)								
	L1 (mm)	C (mm)	D (mm)	T (mm)	Rmin (mm)	10	20	25	30	50	60	75	100	120
P1	20	25	16	3	10	20	20	30	-	-	-	-	-	-
P2	25	30	20	3	10	-	-	50	-	75	-	100	-	-
P2 HP	25	30	20	3	10	-	-	50	-	75	-	100	-	-
P3	30	75	50	5	25	-	-	-	60	-	90	-	132	160
P4	30	120	80	7	40	-	-	-	-	75	-	-	125	-

SUGGESTION ABOUT THE FIXING SCREW

Belt type	Kind of screws	Belt width (mm)								
		10	20	25	30	50	60	75	100	120
		Suggested number of screws								
P1	M5	4	4	-	-	-	-	-	-	-
P2	M6	-	-	4	-	4	-	6	8	-
P2 HP	M6	-	-	4	-	6	-	8	10	-
P3	M8	-	-	-	4	-	6	-	8	12
P4	M10	-	-	4	-	4	-	-	6	-

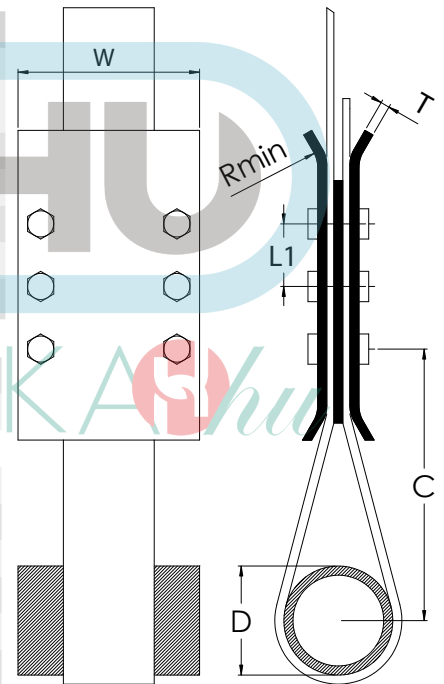

PULLEYS

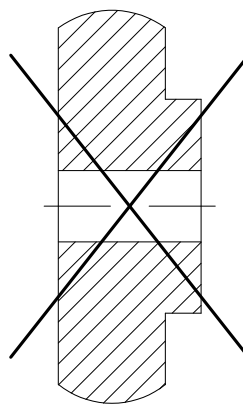
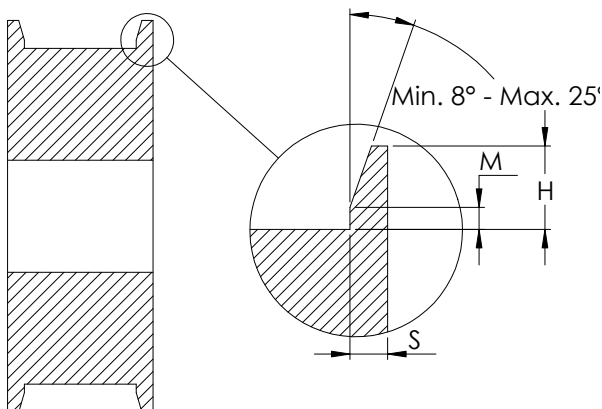

Not suggested

Suggested material: Aluminium or Zinked steel
Maximum superficial roughness: 1.6 Ra

Flanges according the table

Belt type	S (mm)	M (mm)	H (mm)
P1	1,5	0,4+0,3/0	2,1+0,25/0
P2	2,3	0,4+0,3/0	2,1+0,25/0
P2 HP	2,3	0,4+0,3/0	2,1+0,25/0
P3	3	0,9+0,5/0	5+0,25/0
P4	3	0,9+0,5/0	5+0,25/0

H: minimum height of flanges
S: minimum thickness of flanges
Rounded corner not quoted R = 0,8 mm