



# USER MANUAL

# MSI20 SERIES INVERTER

**EKSZIJ.HU**

## Content

<b>CONTENT</b> .....	<b>3</b>
1.1 Safety definition .....	6
1.2 Warning symbols .....	6
1.3 Safety guidelines .....	6
1.3.1 Delivery and installation .....	7
1.3.2 Commissioning and running .....	7
1.3.3 Maintenance and replacement of components .....	8
1.3.4 What to do after scrapping .....	8
<b>2 PRODUCT OVERVIEW</b> .....	<b>8</b>
2.1 Quick start-up .....	8
2.1.1 Unpacking inspection .....	8
2.1.2 Application confirmation .....	8
2.1.3 Environment .....	8
2.1.4 Installation confirmation .....	9
2.1.5 Basic commissioning .....	9
2.2 Product specification .....	9
2.3 Name plate .....	11
2.4 Type designation key .....	11
2.5 Rated specifications .....	11
2.6 Structure diagram .....	12
<b>3 INSTALLATION GUIDELINES</b> .....	<b>14</b>
3.1 Mechanical installation .....	14
3.1.1 Installation environment .....	14
3.1.2 Installation direction .....	15
3.1.3 Installation manner .....	15
3.2 Standard wiring .....	16
3.2.1 Connection diagram of main circuit .....	16
3.2.2 Terminals figure of main circuit .....	16
3.2.3 Wiring of terminals in main circuit .....	17
3.2.4 Wiring diagram of control circuit .....	18
3.2.5 Terminals of control circuit .....	18
3.2.6 Input/output signal connection figure .....	19
3.3 Overview of STO function .....	20
3.3.1 Logic table for STO function .....	21
3.3.2 Description of STO channel delay .....	21
3.3.3 Self-inspection on STO installation .....	21
3.4 Layout protection .....	22
3.4.1 Protecting the inverter and input power cable in short-circuit situations .....	22
3.4.2 Protecting the motor and motor cables .....	22
3.4.3 Implementing a bypass connection .....	22
<b>4 KEYPAD OPERATION PROCEDURE</b> .....	<b>23</b>
4.1 Keypad introduction .....	23
4.2 Keypad displaying .....	25
4.2.1 Displayed state of stopping parameter .....	25
4.2.2 Displayed state of running parameters .....	25
4.2.3 Displayed state of fault .....	25
4.2.4 Displayed state of function codes editing .....	25
4.3 Keypad operation .....	26
4.3.1 How to modify the function codes of the inverter .....	26
4.3.2 How to set the password of the inverter .....	26

4.3.3	How to watch the inverter state through function codes .....	27
<b>5</b>	<b>FUNCTION PARAMETERS .....</b>	<b>28</b>
<b>6</b>	<b>FAULT TRACKING .....</b>	<b>75</b>
6.1	Maintenance intervals .....	75
6.1.1	Cooling fan .....	77
6.1.2	Capacitors .....	77
6.1.3	Power cable .....	78
6.2	Fault solution .....	78
6.2.1	Alarm and fault indications .....	78
6.2.2	How to reset .....	78
6.2.3	Fault instruction and solution .....	79
6.2.4	Other states .....	83
<b>7</b>	<b>COMMUNICATION PROTOCOL .....</b>	<b>84</b>
7.1	Brief instruction to Modbus protocol .....	84
7.2	Application of the inverter .....	84
7.2.1	Two-wire RS485 .....	84
7.2.2	RTU mode .....	86
7.2.3	ASCII mode .....	88
7.3	Command code and communication data illustration .....	89
7.3.1	RTU mode .....	89
7.3.2	ASCII mode .....	92
7.4	The definition of data address .....	94
7.4.1	The rules of parameter address of the function codes .....	95
7.4.2	The address instruction of other function in Modbus .....	95
7.4.3	Fieldbus ratio values .....	98
7.4.4	Fault message response .....	98
7.5	Example of writing and reading .....	100
7.5.1	Example of reading command 03H .....	100
7.5.2	Example of writing command 06H .....	100
7.5.3	Example of continuous writing command 10H .....	101
7.6	Common communication fault .....	103
	<b>APPENDIX A TECHNICAL DATA .....</b>	<b>104</b>
A.1	Ratings .....	104
A.1.1	Capacity .....	104
A.1.2	Derating .....	104
A.2	CE .....	104
A.2.1	CE marking .....	104
A.2.2	Compliance with the European EMC Directive .....	104
A.3	EMC regulations .....	105
A.3.1	Category C2 .....	105
A.3.2	Category C3 .....	105
	<b>APPENDIX B DIMENSION DRAWINGS .....</b>	<b>106</b>
B.1	External keypad structure .....	106
B.2	Inverter chart .....	106
C.1	Peripheral wiring .....	110
C.2	Power supply .....	111
C.3	Cables .....	111
C.3.1	Power cables .....	111
C.3.2	Control cables .....	111
C.4	Breaker and electromagnetic contactor .....	112
C.5	Reactors .....	113
C.6	Filter .....	114
C.6.1	C3 Filter type instruction .....	114

C.6.2 C3 filter .....	115
C.6.3 Installation instruction for C3 filter.....	115
C.6.4 C2 Filter type instruction .....	116
C.6.5 C2 filter .....	116
C.7 Braking components .....	117
C.7.1 Select the braking components .....	117
C.7.2 Placing the brake resistor.....	118
<b>APPENDIX D FURTHER INFORMATION .....</b>	<b>119</b>
D.1 Product and service inquire .....	119
D.2 Feedback of MORGENSEN Inverters manuals.....	119
D.3 Document library on the Internet .....	119



## Safety Precautions

Please read this manual carefully and follow all safety precautions before moving, installing, operating and servicing the inverter. If ignored, physical injury or death may occur, or damage may occur to the devices.









If any physical injury or death or damage to the devices occurs for ignoring to the safety precautions in the manual, our company will not be responsible for any damages and we are not legally bound in any manner.

### 1.1 Safety definition



Danger:	Serious physical injury or even death may occur if not follow relevant requirements
Warning:	Physical injury or damage to the devices may occur if not follow relevant requirements
Note:	Physical hurt may occur if not follow relevant requirements
Qualified electricians:	People working on the device should take part in professional electrical and safety training, receive the certification and be familiar with all steps and requirements of installing, commissioning, operating and maintaining the device to avoid any emergency.



### 1.2 Warning symbols

Warnings caution you about conditions which can result in serious injury or death and/or damage to the equipment, and advice on how to avoid the danger. Following warning symbols are used in this manual:

Symbols	Name	Instruction	Abbreviation
 Danger	Danger	Serious physical injury or even death may occur if not follow the relative requirements	
 Warning	Warning	Physical injury or damage to the devices may occur if not follow the relative requirements	
 Do not	Electrostatic discharge	Damage to the PCBA board may occur if not follow the relative requirements	
 Hot sides	Hot sides	Sides of the device may become hot. Do not touch.	
Note	Note	Physical hurt may occur if not follow the relative requirements	Note

### 1.3 Safety guidelines

	<ul style="list-style-type: none"> <li>⚡ Only qualified electricians are allowed to operate on the inverter.</li> <li>⚡ Do not carry out any wiring and inspection or changing components when the power supply is applied. Ensure all input power supply is disconnected before wiring and checking and always wait for at least the time designated on the inverter or until the DC bus voltage is less than 36V. Below is the table of the waiting time:</li> </ul>											
	<table border="1" style="width: 100%; border-collapse: collapse;"> <thead> <tr> <th colspan="2">Inverter module</th> <th>Minimum waiting time</th> </tr> </thead> <tbody> <tr> <td>1PH 230V</td> <td>0.4kW-2.2kW</td> <td>5 minutes</td> </tr> <tr> <td>3PH 230V</td> <td>0.4kW-7.5kW</td> <td>5 minutes</td> </tr> <tr> <td>3PH 400V</td> <td>0.75kW-110kW</td> <td>5 minutes</td> </tr> </tbody> </table>	Inverter module		Minimum waiting time	1PH 230V	0.4kW-2.2kW	5 minutes	3PH 230V	0.4kW-7.5kW	5 minutes	3PH 400V	0.75kW-110kW
Inverter module		Minimum waiting time										
1PH 230V	0.4kW-2.2kW	5 minutes										
3PH 230V	0.4kW-7.5kW	5 minutes										
3PH 400V	0.75kW-110kW	5 minutes										
	⚡ Do not refit the inverter unauthorized; otherwise fire, electric shock or other injury may occur.											

	<ul style="list-style-type: none"> <li>✧ The base of the radiator may become hot during running. Do not touch to avoid hurt.</li> </ul>
	<ul style="list-style-type: none"> <li>✧ The electrical parts and components inside the inverter are electrostatic. Take measurements to avoid electrostatic discharge during relevant operation.</li> </ul>

### 1.3.1 Delivery and installation

	<ul style="list-style-type: none"> <li>✧ Please install the inverter on fire-retardant material and keep the inverter away from combustible materials.</li> <li>✧ Connect the braking optional parts (braking resistors, braking units or feedback units) according to the wiring diagram.</li> <li>✧ Do not operate on the inverter if there is any damage or components loss to the inverter.</li> <li>✧ Do not touch the inverter with wet items or body, otherwise electric shock may occur.</li> </ul>
-----------------------------------------------------------------------------------	-------------------------------------------------------------------------------------------------------------------------------------------------------------------------------------------------------------------------------------------------------------------------------------------------------------------------------------------------------------------------------------------------------------------------------------------------------------------------------------------------------------

#### Note:

- ✧ Select appropriate moving and installing tools to ensure a safe and normal running of the inverter and avoid physical injury or death. For physical safety, the erector should take some mechanical protective measurements, such as wearing exposure shoes and working uniforms.
- ✧ Ensure to avoid physical shock or vibration during delivery and installation.
- ✧ Do not carry the inverter by its cover. The cover may fall off.
- ✧ Install away from children and other public places.
- ✧ The inverter cannot meet the requirements of low voltage protection in IEC61800-5-1 if the sea level of installation site is above 2000m.
- ✧ The leakage current of the inverter may be above 3.5mA during operation. Ground with proper techniques and ensure the grounding resistor is less than 10Ω. The conductivity of PE grounding conductor is the same as that of the phase conductor (with the same cross sectional area).
- ✧ R, S and T are the input terminals of the power supply, while U, V and W are the motor terminals. Please connect the input power cables and motor cables with proper techniques; otherwise the damage to the inverter may occur.

### 1.3.2 Commissioning and running

	<ul style="list-style-type: none"> <li>✧ Disconnect all power supplies applied to the inverter before the terminal wiring and wait for at least the designated time after disconnecting the power supply.</li> <li>✧ High voltage is present inside the inverter during running. Do not carry out any operation except for the keypad setting.</li> <li>✧ The inverter may start up by itself when P01.21=1. Do not get close to the inverter and motor.</li> <li>✧ The inverter cannot be used as "Emergency-stop device".</li> <li>✧ The inverter cannot be used to brake the motor suddenly. A mechanical braking device should be provided.</li> </ul>
-------------------------------------------------------------------------------------	------------------------------------------------------------------------------------------------------------------------------------------------------------------------------------------------------------------------------------------------------------------------------------------------------------------------------------------------------------------------------------------------------------------------------------------------------------------------------------------------------------------------------------------------------------------------------------------------------------------------------------------------------------

#### Note:

- ✧ Do not switch on or off the input power supply of the inverter frequently.
- ✧ For inverters that have been stored for a long time, check and fix the capacitance and try to run it again before utilization (see Maintenance and Hardware Fault Diagnose).
- ✧ Cover the front board before running, otherwise electric shock may occur.

### 1.3.3 Maintenance and replacement of components

	<ul style="list-style-type: none"> <li>✧ Only qualified electricians are allowed to perform the maintenance, inspection, and components replacement of the inverter.</li> <li>✧ Disconnect all power supplies to the inverter before the terminal wiring. Wait for at least the time designated on the inverter after disconnection.</li> <li>✧ Take measures to avoid screws, cables and other conductive matters to fall into the inverter during maintenance and component replacement.</li> </ul>
-----------------------------------------------------------------------------------	-------------------------------------------------------------------------------------------------------------------------------------------------------------------------------------------------------------------------------------------------------------------------------------------------------------------------------------------------------------------------------------------------------------------------------------------------------------------------------------------------------

#### Note:

- ✧ Please select proper torque to tighten screws.
- ✧ Keep the inverter, parts and components away from combustible materials during maintenance and component replacement.
- ✧ Do not carry out any isolation and pressure test on the inverter and do not measure the control circuit of the inverter by megameter.

### 1.3.4 What to do after scrapping

	<ul style="list-style-type: none"> <li>✧ There are heavy metals in the inverter. Deal with it as industrial effluent.</li> </ul>
-----------------------------------------------------------------------------------	----------------------------------------------------------------------------------------------------------------------------------

## 2 Product Overview

### 2.1 Quick start-up

#### 2.1.1 Unpacking inspection

Check as follows after receiving products:

1. Check that there are no damage and humidification to the package. If not, please contact with local agents or MORGENSEN offices.
2. Check the information on the type designation label on the outside of the package to verify that the drive is of the correct type. If not, please contact with local dealers or MORGENSEN offices.
3. Check that there are no signs of water in the package and no signs of damage or breach to the inverter. If not, please contact with local dealers or MORGENSEN offices.
4. Check the information on the type designation label on the outside of the package to verify that the name plate is of the correct type. If not, please contact with local dealers or MORGENSEN offices.
5. Check to ensure the accessories (including user's manual and control keypad) inside the device is complete. If not, please contact with local dealers or MORGENSEN offices.

#### 2.1.2 Application confirmation

Check the machine before beginning to use the inverter:

1. Check the load type to verify that there is no overload of the inverter during work and check that whether the drive needs to modify the power degree.
2. Check that the actual current of the motor is less than the rated current of the inverter.
3. Check that the control accuracy of the load is the same of the inverter.
4. Check that the incoming supply voltage is correspondent to the rated voltage of the inverter.

#### 2.1.3 Environment

Check as follows before the actual installation and usage:

1. Check that the ambient temperature of the inverter is below 40°C. If exceeds, derate 1% for every additional 1°C. Additionally, the inverter cannot be used if the ambient temperature is above 50°C. <b>Note:</b> for the cabinet inverter, the ambient temperature means the air temperature inside the cabinet.
--------------------------------------------------------------------------------------------------------------------------------------------------------------------------------------------------------------------------------------------------------------------------------------------------------------------------



2. Check that the ambient temperature of the inverter in actual usage is above -10°C. If not, add heating facilities. <b>Note:</b> for the cabinet inverter, the ambient temperature means the air temperature inside the cabinet.
3. Check that the altitude of the actual usage site is below 1000m. If exceeds, derate1% for every additional 100m.
4. Check that the humidity of the actual usage site is below 90% and condensation is not allowed. If not, add additional protection inverters.
5. Check that the actual usage site is away from direct sunlight and foreign objects cannot enter the inverter. If not, add additional protective measures.
6. Check that there is no conductive dust or flammable gas in the actual usage site. If not, add additional protection to inverters.

### 2.1.4 Installation confirmation

Check as follows after the installation:

1. Check that the load range of the input and output cables meet the need of actual load.
2. Check that the accessories of the inverter are correctly and properly installed. The installation cables should meet the needs of every component (including reactors, input filters, output reactors, output filters, DC reactors, braking units and braking resistors).
3. Check that the inverter is installed on non-flammable materials and the calorific accessories (reactors and brake resistors) are away from flammable materials.
4. Check that all control cables and power cables are routed separately and the wire layout complies with EMC requirement.
5. Check that all grounding systems are properly grounded according to the requirements of the inverter.
6. Check that the free space during installation is sufficient according to the instructions in user's manual.
7. Check that the installation conforms to the instructions in user's manual. The drive must be installed in an upright position.
8. Check that the external connection terminals are tightly fastened and the torque is appropriate.
9. Check that there are no screws, cables and other conductive items left in the inverter. If not, get them out.

### 2.1.5 Basic commissioning

Complete the basic commissioning as follows before actual utilization:

1. Autotune. If possible, de-coupled from the motor load to start dynamic autotune. Or if not, static autotune is available.
2. Adjust the ACC/DEC time according to the actual running of the load.
3. Commission the device via jogging and check that the rotation direction is as required. If not, change the rotation direction by changing the wiring of motor.
4. Set all control parameters and then operate.

## 2.2 Product specification

Function		Specification
Power input	Input voltage (V)	AC 1PH 230V(-15%) – 240V(+10%) AC 3PH 230V(-15%) – 240V(+10%) AC 3PH 400V(-15%) – 440V(+10%)
	Input current (A)	Refer to the rated value
	Input frequency (Hz)	50Hz or 60Hz; Allowed range: 47 – 63Hz
Power output	Output voltage (V)	0 – input voltage
	Output current (A)	Refer to the rated value
	Output power (kW)	Refer to the rated value

	Function	Specification
	Output frequency (Hz)	0 – 400Hz
Technical control feature	Control mode	SVPWM, SVC
	Motor	Asynchronous motor
	Adjustable-speed ratio	Asynchronous motor 1:100 (SVC)
	Speed control accuracy	±0.2% (SVC)
	Speed fluctuation	± 0.3% (SVC)
	Torque response	<20ms (SVC)
	Torque control accuracy	10%
	Starting torque	0.5Hz/150% (SVC)
	Overload capability	150% of rated current: 1 minute 180% of rated current: 10 seconds 200% of rated current: 1 second
Running control feature	Frequency setting method	Digital setting, analog setting, pulse frequency setting, multi-step speed running setting, simple PLC setting, PID setting, MODBUS communication setting Shift between the set combination and set channel.
	Auto-adjustment of the voltage	Keep a stable voltage automatically when the grid voltage transients
	Fault protection	Provide comprehensive fault protection functions: overcurrent, overvoltage, undervoltage, overheating, phase loss and overload, etc.
	Start after speed tracking	Smoothing starting for running motor
Peripheral interface	Analog input	1 (AI2) 0 – 10V/0 – 20mA and 1 (AI3) -10 – 10V
	Analog output	2 (AO1, AO2) 0 – 10V/0 – 20mA. * AO2 output only available on MSI20-EU >2.2KW
	Digital input	4 common inputs, the Max frequency: 1kHz; 1 high speed input, the Max frequency: 50kHz
	Digital output	1 Y1 terminal output
	Relay output	2 programmable relay outputs RO1A NO, RO1B NC, RO1C common terminal RO2A NO, RO2B NC, RO2C common terminal Contact capacity: 3A/AC250V *Relay 2 output only available on MSI20-EU > 2.2kW
Others	Temperature of the running environment	-10 to 50°C, derate 1% for every additional 1°C when the temperature is above 40°C
	DC reactor	Standard embedded DC reactor for the inverters (≥18.5kW)
	Installation mode	Wall and rail installation of the inverters (single phase 230V/three phase 400V, ≤2.2KW and three phase 230V, ≤0.75KW) Wall and flange installation of the inverters (three phase 400V, ≥4KW and three phase 230V, ≥1.5KW)
	Braking unit	Standard for the inverters≤37kW and optional for the inverters of 45 – 110kW
	EMI filter	3PH 400V 4kW and above/3PH 230V 1.5kW and above can comply with IEC61800-3 class C3, others can meet requirements of IEC61800-3 class C3 by installing external filter (optional). This series of products can comply with IEC61800-3 class C2

Function	Specification
	by installing external filter (optional).
Ambient environment	-10 to 50°C, derate 1% for every additional 1°C
Elevation	Below 1000m. If the elevation is above 1000m, derate 1% for every additional 100m.
Protection level	IP20 Note: The inverter with plastic casing should be installed in metal distribution cabinet which conforms to IP20 and the top of which conforms to IP3X.
Pollution level	Level 2
Safety regulation	Comply with CE requirements
Cooling	Air-cooling

### 2.3 Name plate

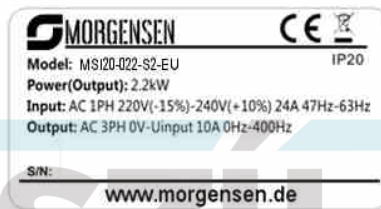

Figure 2-1 Name plate

**Note:** This is the example for the standard products. And the CE/TUV/IP20 will be marked according to the actual.

### 2.4 Type designation key

The type designation contains information on the inverter. The user can find the type designation on the type designation label attached to the inverter or the simple name plate.

**MSI20 - 022 - S2 -EU**

①                      ②                      ③                      ④

Figure 2-2 Product type

Key	NO.	Instruction	Content
Product abbreviation	①	Abbreviation for product series	Name of the series
Rated power	②	Power range + load type	055: 55kW; G — Constant torque load
Voltage degree	③	Voltage degree	S2: 1PH 220V (-15%)V – 240V (+10%) 2: 3PH 220V (-15%)V – 240V (+10%) 4. 3PH 380V (-15%)V – 440V (+10%)
Additional remark 2	④		EU: Built-in safe torque off function

### 2.5 Rated specifications

Model	Voltage degree	Rated output power (kW)	Rated input current (A)	Rated output current (A)	STO function
MSI20-004-S2-EU	Single	0.4	6.5	2.5	Class SIL2

Model	Voltage degree	Rated output power (kW)	Rated input current (A)	Rated output current (A)	STO function		
MSI20-007-S2-EU	phase 230V	0.75	9.3	4.2	PLd CAT.3		
MSI20-015-S2-EU		1.5	15.7	7.5			
MSI20-022-S2-EU		2.2	24	10			
MSI20-004-2-EU	Three phase 230V	0.4	3.7	2.5	Class SIL3 PLe CAT.3		
MSI20-007-2-EU		0.75	5	4.2			
MSI20-015-2-EU		1.5	7.7	7.5			
MSI20-022-2-EU		2.2	11	10			
MSI20-004G-2-EU		4	17	16			
MSI20-5R5G-2-EU		5.5	21	20			
MSI20-7R5G-2-EU		7.5	31	30			
MSI20-0R7G-4-EU		Three phase 400V	0.75	3.4		2.5	Class SIL2 PLd CAT.3
MSI20-1R5G-4-EU			1.5	5.0		4.2	
MSI20-2R2G-4-EU	2.2		5.8	5.5			
MSI20-4R0G-4-EU	4		13.5	9.5	Class SIL3 PLe CAT.3		
MSI20-5R5G-4-EU	5.5		19.5	14			
MSI20-7R5G-4-EU	7.5		25	18.5			
MSI20-011G-4-EU	11		32	25			
MSI20-015G-4-EU	15		40	32			
MSI20-018G-4-EU	18.5		47	38			
MSI20-022G-4-EU	22		51	45			
MSI20-030G-4-EU	30		70	60			
MSI20-037G-4-EU	37		80	75			
MSI20-045G-4-EU	45		98	92			
MSI20-045G-4-B-EU	45		98	92			
MSI20-055G-4-EU	55		128	115			
MSI20-055G-4-B-EU	55		128	115			
MSI20-075G-4-EU	75		139	150			
MSI20-075G-4-B-EU	75		139	150			
MSI20-090G-4-EU	90		168	180			
MSI20-090G-4-B-EU	90		168	180			
MSI20-110G-4-EU	110		201	215			
MSI20-110G-4-B-EU	110	201	215				

## 2.6 Structure diagram

Below is the layout figure of the inverter (Three phase 400V,  $\leq 2.2\text{kW}$ ) (take the inverter of 0.75kW as the example).

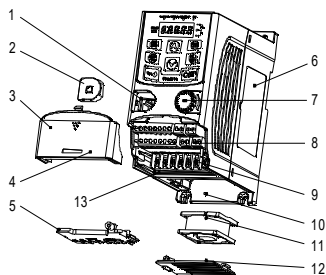

Figure 2-3 Product structure (Three phase 400V, ≤2.2kW)

Serial No.	Name	Illustration
1	External keypad port	Connect the external keypad
2	Port cover	Protect the external keypad port
3	Cover	Protect the internal parts and components
4	Hole for the sliding cover	Fix the sliding cover
5	Trunking board	Protect the inner components and fix the cables of the main circuit
6	Name plate	See <b>Product Overview</b> for detailed information
7	Potentiometer knob	Refer to the <b>Keypad Operation Procedure</b>
8	Control terminals	See <b>Electric Installation</b> for detailed information
9	Main circuit terminals	See <b>Electric Installation</b> for detailed information
10	Screw hole	Fix the fan cover and fan
11	Cooling fan	See <b>Maintenance and Hardware Fault Diagnose</b> for detailed information
12	Fan cover	Protect the fan
13	Bar code	The same as the bar code on the name plate <b>Note:</b> The bar code is on the middle shell which is under the cover
<b>Note:</b> In above figure, the screws at 4 and 10 are provided with packaging and specific installation depends on the requirements of customers.		

Below is the layout figure of the inverter (Three phase 400V, ≥4kW) (take the inverter of 4kW as the example).

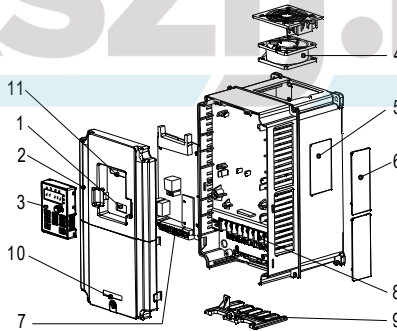



Figure 2-3 Product structure (Three phase 400V, ≥4kW)

Serial No.	Name	Illustration
1	External keypad port	Connect the external keypad
2	Cover	Protect the internal parts and components
3	Keypad	Refer to the <b>Keypad Operation Procedure</b>
4	Cooling fan	See <b>Maintenance and Hardware Fault Diagnose</b> for detailed information
5	Name plate	See <b>Product Overview</b> for detailed information
6	Cover for the heat	Optional, enhancement of the protective degree. It

Serial No.	Name	Illustration
	emission hole	is necessary to derate the inverter because the internal temperature is increasing
7	Control terminals	See <b>Electric Installation</b> for detailed information
8	Main circuit terminals	See <b>Electric Installation</b> for detailed information
9	The cable entry of the main circuit	Fix the cables
10	Simple name plate	Refer to <b>Type Designation Key</b>
11	Bar code	The same as the bar code on the name plate <b>Note:</b> The bar code is on the middle shell which is under the cover

### 3 Installation Guidelines

The chapter describes the mechanical installation and electric installation.

	<ul style="list-style-type: none"> <li>✧ Only qualified electricians are allowed to carry out what described in this chapter. Please operate as the instructions in <b>Safety Precautions</b>. Ignoring these may cause physical injury or death or damage to the devices.</li> <li>✧ Ensure the power supply of the inverter is disconnected during the operation. Wait for at least the time designated after the disconnection if the power supply is applied.</li> <li>✧ The installation and design of the inverter should be complied with the requirement of the local laws and regulations in the installation site. If the installation infringes the requirement, our company will exempt from any responsibility. Additionally, if users do not comply with the suggestion, some damage beyond the assured maintenance range may occur.</li> </ul>
-----------------------------------------------------------------------------------	---------------------------------------------------------------------------------------------------------------------------------------------------------------------------------------------------------------------------------------------------------------------------------------------------------------------------------------------------------------------------------------------------------------------------------------------------------------------------------------------------------------------------------------------------------------------------------------------------------------------------------------------------------------------------------------------------------------------------------------------------------------------------------------------------------------------------------------------------------------

#### 3.1 Mechanical installation

##### 3.1.1 Installation environment

The installation environment is the safeguard for a full performance and long-term stable functions of the inverter. Check the installation environment as follows:

Environment	Conditions
Installation site	Indoor
Environment temperature	<p>-10°C – +50°C, and the temperature changing rate is less than 0.5°C/minute. If the ambient temperature of the inverter is above 40°C, derate 1% for every additional 1°C.</p> <p>It is not recommended to use the inverter if the ambient temperature is above 50°C.</p> <p>In order to improve the reliability of the device, do not use the inverter if the ambient temperature changes frequently.</p> <p>Please provide cooling fan or air conditioner to control the internal ambient temperature below the required one if the inverter is used in a close space such as in the control cabinet.</p> <p>When the temperature is too low, if the inverter needs to restart to run after a long stop, it is necessary to provide an external heating device to increase the internal temperature, otherwise damage to the devices may occur.</p>
Humidity	<p>RH≤90%</p> <p>No condensation is allowed.</p>
Storage	-40°C – +70°C, and the temperature changing rate is less than 1°C/minute.

Environment	Conditions
temperature	
Running environment condition	The installation site of the inverter should: keep away from the electromagnetic radiation source; keep away from contaminative air, such as corrosive gas, oil mist and flammable gas; ensure foreign objects, such as metal power, dust, oil, water cannot enter into the inverter (do not install the inverter on the flammable materials such as wood); keep away from direct sunlight, oil mist, steam and vibration environment.
Altitude	Below 1000m If the sea level is above 1000m, please derate 1% for every additional 100m.
Vibration	$\leq 5.8\text{m/s}^2$ (0.6g)
Installation direction	The inverter should be installed on an upright position to ensure sufficient cooling effect.

**Note:**

- ◆ MSI20-EU series inverters should be installed in a clean and ventilated environment according to enclosure classification.
- ◆ Cooling air must be clean, free from corrosive materials and electrically conductive dust.

**3.1.2 Installation direction**

The inverter may be installed on the wall or in a cabinet.

The inverter needs be installed in the vertical position. Check the installation site according to the requirements below. Refer to chapter **Dimension Drawings** in the appendix for frame details.

**3.1.3 Installation manner**

(1) Wall and rail mounting for the inverters (single phase 230V/three phase 400V,  $\leq 2.2\text{KW}$  and three phase 230V,  $\leq 0.75\text{KW}$ )

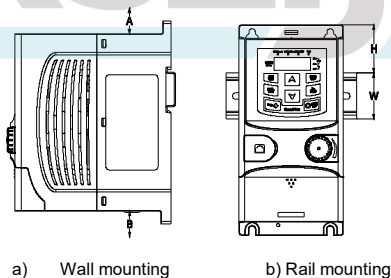

Figure 3-1 Installation

**Note:** the minimum space of A and B is 100mm if H is 36.6mm and W is 35.0mm.

(2) Wall and flange mounting for the inverters (three phase 400V,  $\geq 4\text{KW}$  and three phase 230V,  $\geq 1.5\text{KW}$ )

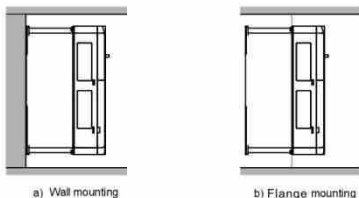

Figure 3-2 Installation

- (1) Locate the position of the installation hole.
- (2) Fix the screw or nut on the located position.
- (3) Put the inverter against the wall.
- (4) Tighten up the screws.

### 3.2 Standard wiring

#### 3.2.1 Connection diagram of main circuit

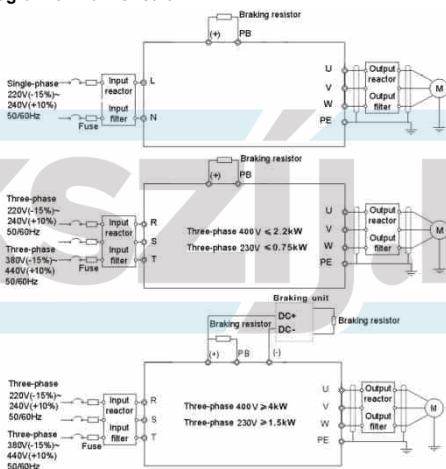

Figure 3-3 Connection diagram of main circuit

#### Note:

- ◆ The fuse, braking resistor, input reactor, input filter, output reactor, output filter are optional parts. Please refer to **Peripheral Optional Parts** for detailed information.
- ◆ Remove the yellow warning labels of PB, (+) and (-) on the terminals before connecting the braking resistor; otherwise poor connection may be occur.

#### 3.2.2 Terminals figure of main circuit

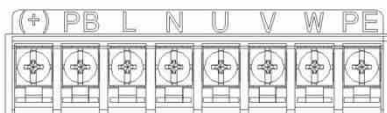

Figure 3-4 1PH terminals of main circuit (single phase)



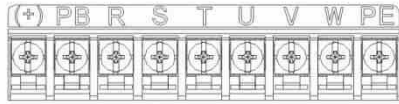

Figure 3-5 3PH terminals of main circuit (230V,  $\leq 0.75\text{kW}$ , and 400V,  $\leq 2.2\text{kW}$ )



Figure 3-6 3PH terminals of main circuit (230V,  $\leq 1.5\text{kW}$ , and 400V, 4-22kW)



Figure 3-7 3PH terminals of main circuit (30-37kW)

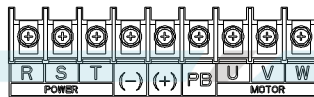

Figure 3-8 3PH terminals of main circuit (45-110kW)

Terminal	Function
L, N	Single phase AC input terminals which are generally connected with the power supply.
R, S, T	Three phase AC input terminals which are generally connected with the power supply.
PB, (+)	External dynamic braking resistor terminal
(+), (-)	Input terminal of the DBU or DC bus
U, V, W	Three phase AC input terminals which are generally connected with the motor.
PE	Protective grounding terminal

**Note:**

- ◆ Do not use asymmetrically motor cables. If there is a symmetrically grounding conductor in the motor cable in addition to the conductive shield, connect the grounding conductor to the grounding terminal at the inverter and motor ends.
- ◆ Route the motor cable, input power cable and control cables separately.

**3.2.3 Wiring of terminals in main circuit**

1. Fasten the grounding conductor of the input power cable with the grounding terminal of the inverter (**PE**) by **360** degree grounding technique. Connect the phase conductors to **L1**, **L2** and **L3** terminals and fasten.
2. Strip the motor cable and connect the shield to the grounding terminal of the inverter by **360** degree grounding technique. Connect the phase conductors to **U**, **V** and **W** terminals and fasten.
3. Connect the optional brake resistor with a shielded cable to the designated position by the same procedures in the previous step.

4. Secure the cables outside the inverter mechanically.

### 3.2.4 Wiring diagram of control circuit

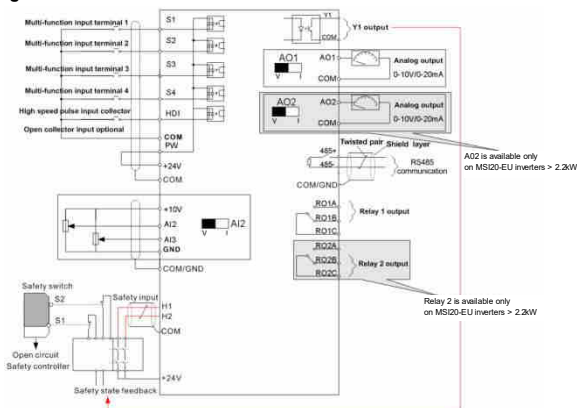

Figure 3-9 Wiring of control circuit

### 3.2.5 Terminals of control circuit

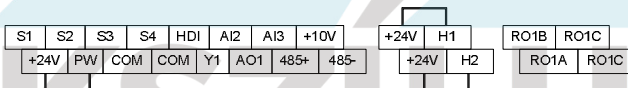

Fig 3-10 Connection terminal diagram for inverters  $\leq 2.2\text{kW}$

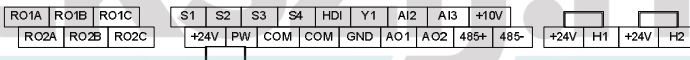

Fig 3-11

Connection terminal diagram for inverters  $\geq 4\text{kW}$

Type	Terminal name	Function description	Technical specifications
Communication	485+	485 communication	485 communication interface
	485-		
Digital input/output	S1	Digital input	1. Internal impedance: 3.3kΩ 2. 12 – 30V voltage input is available 3. The terminal is the dual-direction input terminal 4. Max input frequency: 1kHz
	S2		
	S3		
	S4		
	HDI	High frequency input channel	Except for S1 – S4, this terminal can be used as high frequency input channel. Max input frequency: 50kHz Duty cycle: 30% – 70%
PW	Digital power supply	To provide the external digital power supply Voltage range: 12 – 30V	
Y1	Digital output	1. Contact capacity: 50mA/30V; 2. Output frequency range: 0 – 1kHz; 3. Default is STO state output indicator.	

Type	Terminal name	Function description	Technical specifications
STO function input	24V-H1	STO input 1	1. Safe torque stop (STO) redundant input, externally connected to NC contact, STO acts when the contact is open, and the drive stops output; 2. The safe input signal cable should be shield cable within 25m. 3. When employing STO function, please disassemble the short circuit plate on the terminals shown in fig 3.10 and fig 3.11.
	24V-H2	STO input 2	
24V power supply	+24V	24V power supply	External 24V±10% power supply and the maximum output current is 200mA. Generally used as the operation power supply of digital input and output or external sensor power supply
	COM		
Analog input/output	+10V	External 10V reference power supply	10V reference power supply Max output current: 50mA As the adjusting power supply of the external potentiometer Potentiometer resistance: 5kΩ above
	AI2	Analog input	1. Input range: AI2 voltage and current can be chose: 0 – 10V/0 – 20mA; AI3: -10V – +10V. 2. Input impedance: voltage input: 20kΩ; current input: 500Ω. 3. Voltage or current input can be set by dip switch. 4. Resolution: the minimum AI2/AI3 is 10mV/20mV when 10V corresponds to 50Hz.
	AI3		
	GND	Analog reference ground	Analog reference ground
	AO1	Analog output	1. Output range: 0 – 10V voltage or 0 – 20mA current; 2. Voltage or current output is set by jumpers or toggle switch; 3. Error ±1%, 25°C; 4. There is only one AO1 for inverters ≤ 2.2kW.
	AO2		
Relay output	RO1A	Relay 1 NO contact	1. Contact capacity: 3A/AC250V, 1A/DC30V; 2. Please note that it should not be used as high frequency switch output; 3. There is only one relay output for inverters ≤2.2kW.
	RO1B	Relay 1 NC contact	
	RO1C	Relay 1 common contact	
	RO2A	Relay 2 NO contact	
	RO2B	Relay 2 NC contact	
	RO2C	Relay 2 common contact	

### 3.2.6 Input/output signal connection figure

Please use U-shaped contact tag to set NPN mode or PNP mode and the internal or external power supply. The default setting is NPN internal mode.

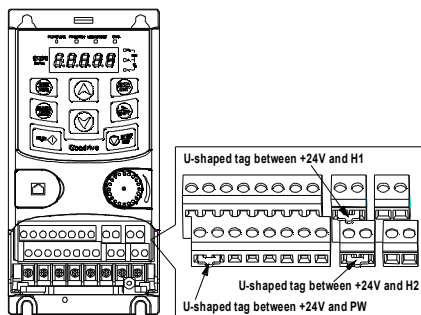

Figure 3-12 U-shaped contact tag

If the signal is from NPN transistor, please set the U-shaped contact tag between +24V and PW as below according to the used power supply.

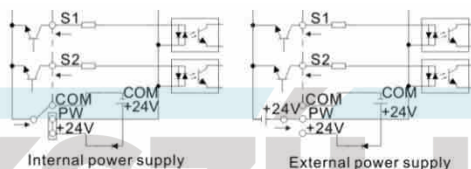

Figure 3-13 NPN modes

If the signal is from PNP transistor, please set the U-shaped contact tag as below according to the used power supply.

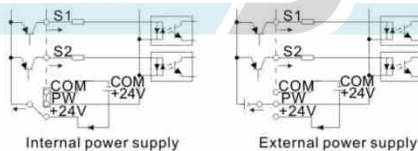
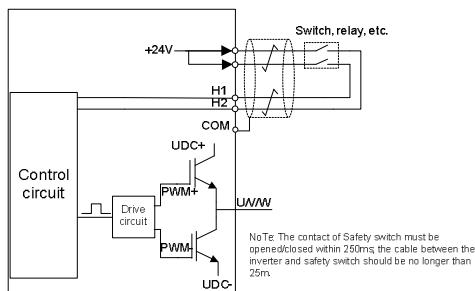

Figure 3-14 PNP modes

### 3.3 Overview of STO function

Reference standards: IEC 61508-1, IEC 61508-2, IEC 61508-3, IEC 61508-4, IEC 62061, ISO 13849-1, IEC 61800-5-2.

The STO function can be used where main power of the drive is on to prevent unexpected start. The function cuts off the drive signal to disable the drive output, thus preventing motor from unexpected start (refer to below figure). After enabling STO function, short-time operations (like non-electrical cleaning-up in lathe industry) and/or maintenance on non-electrical parts can be conducted.



### 3.3.1 Logic table for STO function

Input states and corresponding faults of STO function:

STO input state	Corresponding STO fault
H1, H2 opens simultaneously	Trigger STO function, the drive can't operate normally
H1, H2 closes simultaneously	Don't trigger STO function, the drive can operate normally
Either H1 or H2 opens or closes	Trigger STL1/STL2/STL3 fault, fault code: 38: Safety circuit of channel 1 is abnormal (STL1) 39: Safety circuit of channel 2 is abnormal (STL2) 40: Internal circuit is abnormal (STL3)

### 3.3.2 Description of STO channel delay

STO channel trigger and indication delay time:

STO mode	STO trigger and indication delay <sup>1,2)</sup>
STO fault: STL1	Trigger delay < 10ms, Indication delay < 280ms
STO fault: STL2	Trigger delay < 10ms, Indication delay < 280ms
STO fault: STL3	Trigger delay < 10ms, Indication delay < 280ms
STO fault: STO	Trigger delay < 10ms, Indication delay < 100ms

<sup>1)</sup> STO trigger delay = the delay between triggering STO and cutting off drive output

<sup>2)</sup> STO indication delay = the delay between triggering STO and indicating STO output state

### 3.3.3 Self-inspection on STO installation

Before installing STO, please perform self-inspection according to below table to ensure the effectiveness of STO.

Actions	
<input type="checkbox"/>	Ensure that the drive can be run and stopped freely during commissioning.
<input type="checkbox"/>	Stop the drive (if running), cut off input power and isolate the drive from the power cable via the switch
<input type="checkbox"/>	Check STO circuit connection against circuit diagram.
<input type="checkbox"/>	Check that the shield of STO input cable is connected to +24V reference GND COM
<input type="checkbox"/>	Power on
<input type="checkbox"/>	Test the operation of STO when the motor is stopped: <ul style="list-style-type: none"> <li>• Give a stop command to the drive (if running) and wait until the motor shaft is at standstill.</li> <li>• Activate STO function and give a start command to the drive, ensure the motor stays at standstill</li> <li>• Inactivate STO circuit</li> </ul>
<input type="checkbox"/>	Restart the drive and check if the motor runs normally
<input type="checkbox"/>	Test the operation of STO function when the motor is running:

	<ul style="list-style-type: none"> <li>▪ Start the drive and ensure the motor runs normally.</li> <li>▪ Activate STO circuit.</li> <li>▪ The drive reports STO fault (refer to fault and countermeasure in page X), ensure that motor coast to stop and stops rotation.</li> <li>▪ Inactivate STO circuit</li> </ul>
□	Restart the drive and check if the motor runs normally

### 3.4 Layout protection

#### 3.4.1 Protecting the inverter and input power cable in short-circuit situations

Protect the inverter and input power cable in short circuit situations and against thermal overload.

Arrange the protection according to the following guidelines.

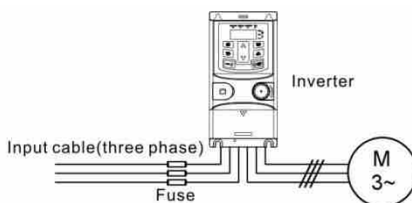

Figure 3-15 Fuse configuration

**Note:** Select the fuse as the manual indicated. The fuse will protect the input power cable from damage in short-circuit situations. It will protect the surrounding devices when the internal of the inverter is short circuited.

#### 3.4.2 Protecting the motor and motor cables

The inverter protects the motor and motor cable in a short-circuit situation when the motor cable is dimensioned according to the rated current of the inverter. No additional protection devices are needed.

	<p>⚡ <b>If the inverter is connected to multiple motors, a separate thermal overload switch or a circuit breaker must be used for protecting each cable and motor. These devices may require a separate fuse to cut off the short-circuit current.</b></p>
--	------------------------------------------------------------------------------------------------------------------------------------------------------------------------------------------------------------------------------------------------------------

#### 3.4.3 Implementing a bypass connection

It is necessary to set power frequency and variable frequency conversion circuits for the assurance of continuous normal work of the inverter if faults occur in some significant situations.

In some special situations, for example, if it is only used in soft start, the inverter can be converted into power frequency running after starting and some corresponding bypass should be added.

	<p>⚡ <b>Never connect the supply power to the inverter output terminals U, V and W. Power line voltage applied to the output can result in permanent damage to the inverter.</b></p>
--	--------------------------------------------------------------------------------------------------------------------------------------------------------------------------------------

If frequent shifting is required, employ mechanically connected switches or contactors to ensure that the motor terminals are not connected to the AC power line and inverter output terminals simultaneously.

## 4 Keypad Operation Procedure

### 4.1 Keypad introduction

The keypad is used to control MSI20-EU series inverters, read the state data and adjust parameters.

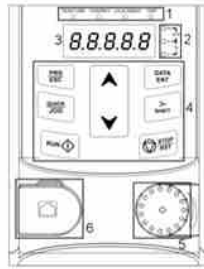

Figure 4-1 Film keypad

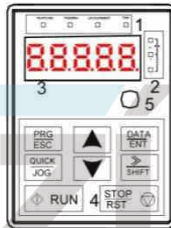

Figure 4-2 External keypad

**Note:**

1. The film keypad is standard for the inverters of 1PH 230V/3PH 400V ( $\leq 2.2\text{kW}$ ) and the inverters of 3PH ( $\leq 0.75\text{kW}$ ). The external keypad is standard for the inverters of 3PH 400V ( $\geq 4\text{kW}$ ) and 3PH 230V ( $\geq 1.5\text{kW}$ ).
2. The external keypads are optional (including the external keypads with and without the function of parameter copying).

No.	Name	Description
1	State LED	<b>RUN/TUNE</b> LED off means that the inverter is in the stopping state; LED blinking means the inverter is in the parameter autotune state; LED on means the inverter is in the running state.
		<b>FWD/REV</b> FED/REV LED LED off means the inverter is in the forward rotation state; LED on means the inverter is in the reverse rotation state
		<b>LOCAL/REMOT</b> LED for keypad operation, terminals operation and remote communication control LED off means that the inverter is in the keypad operation state; LED blinking means the inverter is in the terminals operation state; LED on means the inverter is in the remote communication control state.

No.	Name	Description					
			LED for faults LED on when the inverter is in the fault state; LED off in normal state; LED blinking means the inverter is in the pre-alarm state.				
2	Unit LED	Mean the unit displayed currently					
			Hz Frequency unit				
			RPM Rotating speed unit				
			A Current unit				
			% Percentage				
			V Voltage unit				
3	Code displaying zone	5-figure LED display displays various monitoring data and alarm code such as set frequency and output frequency.					
		<b>Displayed word</b>	<b>Corresponding word</b>	<b>Displayed word</b>	<b>Corresponding word</b>	<b>Displayed word</b>	<b>Corresponding word</b>
		0	0	1	1	2	2
		3	3	4	4	5	5
		6	6	7	7	8	8
		9	9	A	A	B	B
		C	C	d	d	E	E
		F	F	H	H	I	I
		L	L	N	N	n	n
		o	o	P	P	r	r
		S	S	t	t	U	U
		v	v	.	.	-	-
4	Buttons		Programming key	Enter or escape from the first level menu and remove the parameter quickly			
			Entry key	Enter the menu step-by-step Confirm parameters			
			UP key	Increase data or function code progressively			
			DOWN key	Decrease data or function code progressively			
			Right-shift key	Move right to select the displaying parameter circularly in stopping and running mode. Select the parameter modifying digit during the parameter modification			
			Run key	This key is used to operate on the inverter in key operation mode			
			Stop/Reset key	This key is used to stop in running state and it is limited by function code P07.04 This key is used to reset all control modes in the fault alarm state			
			Quick key	The function of this key is confirmed by function code P07.02.			
5	Analog potential meter	AI1, When the external common keypad (without the function of parameter copy ) is valid, the difference between the local keypad AI1 and the external keypad AI1 is:					



No.	Name	Description
		When the external keypad AI1 is set to the Min. value, the local keypad AI1 will be valid and P17.19 will be the voltage of the local keypad AI1; otherwise, the external keypad AI1 will be valid and P17.19 will be the voltage of the external keypad AI1. <b>Note:</b> If the external keypad AI1 is frequency reference source, adjust the local potentiometer AI1 to 0V/0mA before starting the inverter.
6	Keypad port	External keypad port. When the external keypad with the function of parameter copying is valid, the local keypad LED is off; When the external keypad without the function of parameter copying is valid, the local and external keypad LEDs are on. <b>Note:</b> Only the external keypad which has the function of parameters copy owns the function of parameters copy, other keypads do not have. (only for the inverters≤2.2kW)



## 4.2 Keypad displaying

The keypad displaying state of MSI20-EU series inverters is divided into stopping state parameter, running state parameter, function code parameter editing state and fault alarm state and so on.



### 4.2.1 Displayed state of stopping parameter



When the inverter is in the stopping state, the keypad will display stopping parameters which is shown in figure 4-2.

In the stopping state, various kinds of parameters can be displayed. Select the parameters to be displayed or not by P07.07. See the instructions of P07.07 for the detailed definition of each bit.



In the stopping state, there are 14 stopping parameters can be selected to be displayed or not. They are: set frequency, bus voltage, input terminals state, output terminals state, PID given, PID feedback, torque set value, AI1, AI2, AI3, HDI, PLC and the current stage of multi-step speeds, pulse counting value, length value. P07.07 can select the parameter to be displayed or not by bit and /SHIFT can shift the parameters form left to right,  (P07.02=2) can shift the parameters form right to left.

### 4.2.2 Displayed state of running parameters

After the inverter receives valid running commands, the inverter will enter into the running state and the keypad will display the running parameters.  LED on the keypad is on, while the  is determined by the current running direction which is shown as figure 4-2.

In the running state, there are 24 parameters can be selected to be displayed or not. They are: running frequency, set frequency, bus voltage, output voltage, output torque, PID given, PID feedback, input terminals state, output terminals state, torque set value, length value, PLC and the current stage of inverter overload, ramp given value, linear speed, AC input current. P07.05 and P07.06 can select the parameter to be displayed or not by bit and /SHIFT can shift the parameters form left to right,  (P07.02=2) can shift the parameters from right to left.

### 4.2.3 Displayed state of fault

If the inverter detects the fault signal, it will enter into the fault pre-alarm displaying state. The keypad will display the fault code by flicking. The  LED on the keypad is on, and the fault reset can be operated by the  on the keypad, control terminals or communication commands.

### 4.2.4 Displayed state of function codes editing





In the state of stopping, running or fault, press  to enter into the editing state (if there is a password, see P07.00 ).The editing state is displayed on two classes of menu, and the order is: function code group/function code number→function code parameter, press  into the displayed state of function parameter. On this state, press  to save the parameters or press  to escape.



Figure 4-3 Displayed state

### 4.3 Keypad operation

Operate the inverter via operation panel. See the detailed structure description of function codes in the brief diagram of function codes.

#### 4.3.1 How to modify the function codes of the inverter

The inverter has three levels menu, which are:

1. Group number of function code (first-level menu)
2. Tab of function code (second-level menu)
3. Set value of function code (third-level menu)

Remarks: Press both the **PRG/ESC** and the **DATA/ENT** can return to the second-level menu from the third-level menu. The difference is: pressing **DATA/ENT** will save the set parameters into the control panel, and then return to the second-level menu with shifting to the next function code automatically; while pressing **PRG/ESC** will directly return to the second-level menu without saving the parameters, and keep staying at the current function code.

Under the third-level menu, if the parameter has no flickering bit, it means the function code cannot be modified. The possible reasons could be:

- 1) This function code is not modifiable parameter, such as actual detected parameter, operation records and so on;
- 2) This function code is not modifiable in running state, but modifiable in stop state.

Example: Set function code P00.01 from 0 to 1.

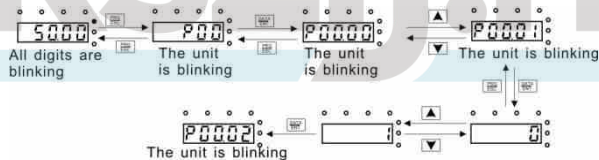

Note: when setting, **PRG/ESC** and **DATA/ENT** can be used to shift and adjust.

Figure 4-4 Sketch map of modifying parameters

#### 4.3.2 How to set the password of the inverter

MSI20-EU series inverters provide password protection function to users. Set P7.00 to gain the password and the password protection becomes valid instantly after quitting from the function code editing state. Press **PRG/ESC** again to the function code editing state, "0.0.0.0.0" will be displayed. Unless using the correct password, the operators cannot enter it.

Set P7.00 to 0 to cancel password protection function.

The password protection becomes effective instantly after retreating from the function code editing state. Press **PRG/ESC** again to the function code editing state, "0.0.0.0.0" will be displayed. Unless using the correct password, the operators cannot enter it.



## 5 Function Parameters

The function parameters of MSI20-EU series inverters have been divided into 30 groups (P00 – P29) according to the function, of which P18 – P28 are reserved. Each function group contains certain function codes applying 3-level menus. For example, “P08.08” means the eighth function code in the P8 group function, P29 group is factory reserved, and users are forbidden to access these parameters.

For the convenience of function codes setting, the function group number corresponds to the first level menu, the function code corresponds to the second level menu and the function code corresponds to the third level menu.

1. Below is the instruction of the function lists:

**The first column** “Function code”: codes of function parameter group and parameters:

**The second column** “Name”: full name of function parameters:

**The third column** “Detailed illustration of parameters”: Detailed illustration of the function parameters

**The fourth column** “Default value”: the original factory set value of the function parameter:

**The fifth column** “Modify”: the modifying character of function codes (the parameters can be modified or not and the modifying conditions), below is the instruction:

“○”: means the set value of the parameter can be modified on stop and running state;

“⊙”: means the set value of the parameter cannot be modified on the running state;

“●”: means the value of the parameter is the real detection value which cannot be modified.

Function code	Name	Detailed instruction of parameters	Default value	Modify
<b>P00 Group Basic function group</b>				
P00.00	Speed control mode	0: SVC 0 .No need to install encoders. Suitable in applications which need low frequency, big torque for high accuracy of rotating speed and torque control. Relative to mode 1, it is more suitable for the applications which need small power. 1: SVC 1 1 is suitable in high performance cases with the advantage of high accuracy of rotating speed and torque. It does not need to install pulse encoder. 2: SVPWM control 2 is suitable in applications which do not need high control accuracy, such as the load of fan and pump. One inverter can drive multiple motors. Note: Motor parameter autotuning is required when vector mode is applied.	1	⊙
P00.01	Run command channel	Select the run command channel of the inverter. The control command of the inverter includes: start, stop, forward/reverse rotating, jogging and fault reset. 0: Keypad running command channel (“LOCAL/REMOT” light off) Carry out the command control by <b>RUN</b> , <b>STOP/RST</b> on the keypad. Set the multi-function key <b>QUICK/JOG</b> to <b>FWD/REV</b> shifting function (P07.02=3) to change the running direction; press <b>RUN</b> and <b>STOP/RST</b> simultaneously in running state to	0	○

Function code	Name	Detailed instruction of parameters	Default value	Modify
		<p>make the inverter coast to stop.</p> <p>1: Terminal running command channel (<b>[LOCAL/REMOTE]</b> flickering)</p> <p>Carry out the running command control by the forward rotation, reverse rotation and forward jogging and reverse jogging of the multi-function terminals</p> <p>2: Communication running command channel (<b>[LOCAL/REMOTE]</b> on);</p> <p>The running command is controlled by the upper monitor via communication</p>		
P00.03	Max output frequency	<p>This parameter is used to set the maximum output frequency of the inverter. Users need to pay attention to this parameter because it is the foundation of the frequency setting and the speed of acceleration and deceleration.</p> <p>Setting range: P00.04 – 400.00Hz</p>	50.00Hz	⊙
P00.04	Upper limit of the running frequency	<p>The upper limit of the running frequency is the upper limit of the output frequency of the inverter which is lower than or equal to the maximum frequency.</p> <p>Setting range: P00.05 – P00.03 (max output frequency)</p>	50.00Hz	⊙
P00.05	Lower limit of the running frequency	<p>The lower limit of the running frequency is that of the output frequency of the inverter.</p> <p>The inverter runs at the lower limit frequency if the set frequency is lower than the lower limit.</p> <p><b>Note:</b> Max output frequency ≥ Upper limit frequency ≥ Lower limit frequency</p> <p>Setting range: 0.00Hz – P00.04 (Upper limit of the running frequency)</p>	0.00Hz	⊙
P00.06	A frequency command selection	<p><b>Note:</b> A frequency and B frequency cannot set as the same frequency given method. The frequency source can be set by P00.09.</p>	0	○
P00.07	B frequency command selection	<p>0: Keypad data setting</p> <p>Modify the value of function code P00.10 (set the frequency by keypad) to modify the frequency by the keypad.</p> <p>1: Analog AI1 setting (corresponding keypad potentiometer)</p> <p>2: Analog AI2 setting (corresponding terminal AI2)</p> <p>3: Analog AI3 setting (corresponding terminal AI3)</p> <p>Set the frequency by analog input terminals. MSI20-EU series inverters provide 3 channels analog input terminals as the standard configuration, of which AI1 is adjusting through analog potentiometer, while AI2 is the voltage/current option (0 – 10V/0 – 20mA) which can be shifted by jumpers; while AI3 is voltage input (-10V – +10V).</p> <p><b>Note:</b> when analog AI2 select 0 – 20mA input, the corresponding voltage of 20mA is 10V.</p>	2	○

Function code	Name	Detailed instruction of parameters	Default value	Modify
		<p>100.0% of the analog input setting corresponds to the maximum frequency (function code P00.03) in forward direction and -100.0% corresponds to the maximum frequency in reverse direction (function code P00.03)</p> <p>4: High-speed pulse HDI setting The frequency is set by high-speed pulse terminals. MSI20 series inverters provide 1 high speed pulse input as the standard configuration. The pulse frequency range is 0.00 – 50.00kHz. 100.0% of the high speed pulse input setting corresponds to the maximum frequency in forward direction (function code P00.03) and -100.0% corresponds to the maximum frequency in reverse direction (function code P00.03). <b>Note:</b> The pulse setting can only be input by multi-function terminals HDI. Set P05.00 (HDI input selection) to high speed pulse input, and set P05.49 (HDI high speed pulse input function selection) to frequency setting input.</p> <p>5: Simple PLC program setting The inverter runs at simple PLC program mode when P00.06=5 or P00.07=5. Set P10 (simple PLC and multi-step speed control) to select the running frequency running direction, ACC/DEC time and the keeping time of corresponding stage. See the function description of P10 for detailed information.</p> <p>6: Multi-step speed running setting The inverter runs at multi-step speed mode when P00.06=6 or P00.07=6. Set P05 to select the current running step, and set P10 to select the current running frequency. The multi-step speed has the priority when P00.06 or P00.07 does not equal to 6, but the setting stage can only be the 1 – 15 stage. The setting stage is 1 – 15 if P00.06 or P00.07 equals to 6.</p> <p>7: PID control setting The running mode of the inverter is process PID control when P00.06=7 or P00.07=7. It is necessary to set P09. The running frequency of the inverter is the value after PID effect. See P09 for the detailed information of the preset source, preset value and feedback source of PID.</p> <p>8: MODBUS communication setting The frequency is set by MODBUS communication. See P14 for detailed information.</p> <p>9 – 11: Reserved</p>		
P00.08	B frequency command reference selection	<p>0: Maximum output frequency, 100% of B frequency setting corresponds to the maximum output frequency</p> <p>1: A frequency command, 100% of B frequency setting corresponds to the maximum output</p>	0	○

Function code	Name	Detailed instruction of parameters	Default value	Modify
		frequency. Select this setting if it needs to adjust on the base of A frequency command.		
P00.09	Combination of the setting source	<p>0: A, the current frequency setting is A frequency command</p> <p>1: B, the current frequency setting is B frequency command</p> <p>2: A+B, the current frequency setting is A frequency command + B frequency command</p> <p>3: A-B, the current frequency setting is A frequency command - B frequency command</p> <p>4: Max (A, B): The bigger one between A frequency command and B frequency is the set frequency.</p> <p>5: Min (A, B): The lower one between A frequency command and B frequency is the set frequency.</p> <p><b>Note:</b> The combination manner can be shifted by P05 (terminal function)</p>	0	○
P00.10	Keypad set frequency	When A and B frequency commands are selected as "keypad setting", this parameter will be the initial value of inverter reference frequency Setting range: 0.00 Hz – P00.03 (the Max frequency)	50.00Hz	○
P00.11	ACC time 1	ACC time means the time needed if the inverter speeds up from 0Hz to the max one (P00.03). DEC time means the time needed if the inverter speeds down from the max output frequency to 0Hz (P00.03).	Depend on model	○
P00.12	DEC time 1	MSI20-EU series inverters have four groups of ACC/DEC time which can be selected by P05. The factory default ACC/DEC time of the inverter is the first group. Setting range of P00.11 and P00.12: 0.0 – 3600.0s	Depend on model	○
P00.13	Running direction selection	<p>0: Runs at the default direction, the inverter runs in the forward direction. FWD/REV indicator is off.</p> <p>1: Runs at the opposite direction, the inverter runs in the reverse direction. FWD/REV indicator is on. Modify the function code to shift the rotation direction of the motor. This effect equals to the shifting the rotation direction by adjusting either two of the motor lines (U, V and W). The motor rotation direction can be changed by <b>QUICK/JOG</b> on the keypad. Refer to parameter P07.02.</p> <p><b>Note:</b> When the function parameter comes back to the default value, the motor's running direction will come back to the factory default state, too. In some cases it should be used with caution after commissioning if the change of rotation direction is disabled.</p> <p>2: Forbid to run in reverse direction: It can be used in some special cases if the reverse running is disabled.</p>	0	○

Function code	Name	Detailed instruction of parameters	Default value	Modify																						
P00.14	Carrier frequency setting	<table border="1"> <thead> <tr> <th>Carrier frequency</th> <th>Electromagnetic noise</th> <th>Noise and leakage current</th> <th>Heating eliminating</th> </tr> </thead> <tbody> <tr> <td>1kHz</td> <td>↑ High</td> <td>↑ Low</td> <td>↑ Low</td> </tr> <tr> <td>10kHz</td> <td>↓ Low</td> <td>↓ High</td> <td>↓ High</td> </tr> <tr> <td>15kHz</td> <td>↓ Low</td> <td>↓ High</td> <td>↓ High</td> </tr> </tbody> </table> <p>The relationship table of the motor type and carrier frequency:</p> <table border="1"> <thead> <tr> <th>Motor type</th> <th>Factory setting of carrier frequency</th> </tr> </thead> <tbody> <tr> <td>0.4 – 11kW</td> <td>8kHz</td> </tr> <tr> <td>15 – 110kW</td> <td>4kHz</td> </tr> </tbody> </table> <p>The advantage of high carrier frequency: ideal current waveform, little current harmonic wave and motor noise.  The disadvantage of high carrier frequency: increasing the switch loss, increasing inverter temperature and the impact to the output capacity. The inverter needs to derate on high carrier frequency. At the same time, the leakage and electrical magnetic interference will increase.  Applying low carrier frequency is contrary to the above, too low carrier frequency will cause unstable running, torque decreasing and surge. The manufacturer has set a reasonable carrier frequency when the inverter is in factory. In general, users do not need to change the parameter.  When the frequency used exceeds the default carrier frequency, the inverter needs to derate 10% for each additional 1k carrier frequency.  Setting range: 1.0 – 15.0kHz</p>	Carrier frequency	Electromagnetic noise	Noise and leakage current	Heating eliminating	1kHz	↑ High	↑ Low	↑ Low	10kHz	↓ Low	↓ High	↓ High	15kHz	↓ Low	↓ High	↓ High	Motor type	Factory setting of carrier frequency	0.4 – 11kW	8kHz	15 – 110kW	4kHz	Depend on model	○
Carrier frequency	Electromagnetic noise	Noise and leakage current	Heating eliminating																							
1kHz	↑ High	↑ Low	↑ Low																							
10kHz	↓ Low	↓ High	↓ High																							
15kHz	↓ Low	↓ High	↓ High																							
Motor type	Factory setting of carrier frequency																									
0.4 – 11kW	8kHz																									
15 – 110kW	4kHz																									
P00.15	Motor parameter autotuning	<p>0: No operation  1: Rotation autotuning  Comprehensive motor parameter autotune  It is recommended to use rotation autotuning when high control accuracy is needed.  2: Static autotuning 1 (autotune totally); It is suitable in the cases when the motor cannot de-couple from the load. The autotuning for the motor parameter will impact the control accuracy.  3: Static autotuning 2 (autotune part parameters); when the current motor is motor 1, autotune P02.06, P02.07, P02.08</p>	0	◎																						
P00.16	AVR function selection	<p>0: Invalid  1: Valid during the whole procedure  The auto-adjusting function of the inverter can cancel the impact on the output voltage of the inverter because of the bus voltage fluctuation.</p>	1	○																						

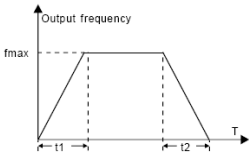
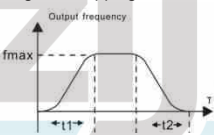

Function code	Name	Detailed instruction of parameters	Default value	Modify
P00.18	Function restore parameter	0: No operation 1: Restore the default value 2: Clear fault records 3: Lock all function codes <b>Note:</b> The function code will restore to 0 after finishing the operation of the selected function code. Restoring to the default value will cancel the user password, please use this function with caution.	0	⊙
<b>P01 Group Start-up and stop control</b>				
P01.00	Start mode	0: Start-up directly; start from the starting frequency P01.01 1: Start-up after DC braking; start the motor from the starting frequency after DC braking (set the parameter P01.03 and P01.04). It is suitable in the cases where reverse rotation may occur to the low inertia load during starting. 2: Start after speed tracking 1 3: Start after speed tracking 2 The direction and speed will be tracked automatically for the smoothing starting of rotating motors. It suits the application with reverse rotation when big load starting. <b>Note:</b> This function is only available for the inverters ≥ 4kW	0	⊙
P01.01	Starting frequency of direct start-up	Starting frequency of direct start-up means the original frequency during the inverter starting. See P01.02 for detailed information. Setting range: 0.00 – 50.00Hz	0.50Hz	⊙
P01.02	Retention time of the starting frequency	Set a proper starting frequency to increase the torque of the inverter during starting. During the retention time of the starting frequency, the output frequency of the inverter is the starting frequency. And then, the inverter will run from the starting frequency to the set frequency. If the set frequency is lower than the starting frequency, the inverter will stop running and keep in the stand-by state. The starting frequency is not limited in the lower limit frequency. <div style="text-align: center;"> </div> Setting range: 0.0 – 50.0s	0.0s	⊙
P01.03	Braking current before starting	The inverter will carry out DC braking at the braking current set before starting and it will speed up after the DC braking time. If the DC braking	0.0%	⊙

Function code	Name	Detailed instruction of parameters	Default value	Modify
P01.04	Braking time before starting	time is set to 0, the DC braking is invalid. The stronger the braking current, the bigger the braking power. The DC braking current before starting means the percentage of the rated current of the inverter. The setting range of P01.03: 0.0 – 100.0% The setting range of P01.04: 0.00 – 50.00s	0.00s	⊙
P01.05	ACC/DEC selection	The changing mode of the frequency during start-up and running. 0: Linear type The output frequency increases or decreases linearly.  1: S curve, the output frequency will increase or decrease according to the S curve S curve is generally used on the applications of gradual starting and stopping, such as elevators. 	0	⊙
P01.06	ACC time of the starting step of S curve	0.0 – 50.0s	0.1s	⊙
P01.07	DEC time of the ending step of S curve		0.1s	⊙
P01.08	Stop selection	0: Decelerate to stop: after the stop command becomes valid, the inverter decelerates to reduce the output frequency during the set time. When the frequency decreases to 0Hz, the inverter stops. 1: Coast to stop: after the stop command becomes valid, the inverter ceases the output immediately. And the load coasts to stop at the mechanical inertia.	0	○
P01.09	Starting frequency of DC braking while stop	Starting frequency of DC braking: start the DC braking when running frequency reaches starting frequency determined by P1.09. Waiting time before DC braking: Inverters blocks the output before starting the DC braking. After this waiting time, the DC braking will be started so	0.00Hz	○
P01.10	Waiting time before DC braking while	as to prevent over-current fault caused by DC	0.00s	○

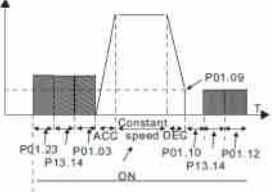
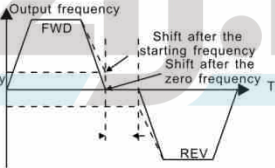
Function code	Name	Detailed instruction of parameters	Default value	Modify
	stop	braking at high speed.		
P01.11	DC braking current while stop	DC braking current: the value of P01.11 is the percentage of rated current of inverter. The bigger the DC braking current is, the greater the braking torque is.	0.0%	○
P01.12	DC braking time while stop	DC braking time: the retention time of DC braking. If the time is 0, the DC braking is invalid. The inverter will stop at the set deceleration time.  Setting range of P01.09: 0.00Hz – P00.03 (the Max frequency) Setting range of P01.10: 0.00 – 50.00s Setting range of P01.11: 0.0 – 100.0% Setting range of P01.12: 0.00 – 50.00s	0.00s	○
P01.13	Dead time of FWD/REV rotation	During the procedure of switching FWD/REV rotation, set the threshold by P01.14, which is as the table below:  Setting range: 0.0 – 3600.0s	0.0s	○
P01.14	Switching between FWD/REV rotation	Set the threshold point of the inverter: 0: Switch after zero frequency 1: Switch after the starting frequency 2: Switch after the speed reach P01.15 and delay for P01.24	0	◎
P01.15	Stopping speed	0.00 – 100.00Hz	0.50Hz	◎
P01.16	Detection of stopping speed	0: Detect at the setting speed 1: Detect at the feedback speed (only valid for vector control)	1	◎
P01.17	Detection time of the feedback speed	When P01.16=1, the actual output frequency of the inverter is less than or equal to P01.15 and is detected during the time set by P01.17, the inverter will stop; otherwise, the inverter stops in the time set by P01.24.	0.50s	◎

Function code	Name	Detailed instruction of parameters	Default value	Modify
		<p>Setting range: 0.00 – 100.00s ( valid only when P01.16=1)</p>		
P01.18	Terminal running protection selection when powering on	<p>When the running command channel is the terminal control, the system will detect the state of the running terminal during powering on.</p> <p>0: The terminal running command is invalid when powering on. Even the running command is detected to be valid during powering on, the inverter won't run and the system keeps in the protection state until the running command is canceled and enabled again.</p> <p>1: The terminal running command is valid when powering on. If the running command is detected to be valid during powering on, the system will start the inverter automatically after the initialization.</p> <p><b>Note:</b> This function should be selected with cautions, or serious result may follow.</p>	0	○
P01.19	The running frequency is lower than the lower limit one (valid if the lower limit frequency is above 0)	<p>This function code determines the running state of the inverter when the set frequency is lower than the lower-limit one.</p> <p>0: Run at the lower-limit frequency</p> <p>1: Stop</p> <p>2: Hibernation</p> <p>The inverter will coast to stop when the set frequency is lower than the lower-limit one. If the set frequency is above the lower limit one again and it lasts for the time set by P01.20, the inverter will come back to the running state automatically.</p>	0	◎
P01.20	Hibernation restore delay time	<p>This function code determines the hibernation delay time. When the running frequency of the inverter is lower than the lower limit one, the inverter will stop to stand by.</p> <p>When the set frequency is above the lower limit one again and it lasts for the time set by P01.20, the inverter will run automatically.</p> <p>Setting range: 0.0 – 3600.0s (valid when</p>	0.0s	○

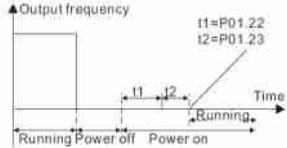
Function code	Name	Detailed instruction of parameters	Default value	Modify
		P01.19=2)		
P01.21	Restart after power off	This function can enable the inverter start or not after the power off and then power on. 0: Disabled 1: Enabled, if the starting need is met, the inverter will run automatically after waiting for the time defined by P01.22.	0	○
P01.22	The waiting time of restart after power off	The function determines the waiting time before the automatic running of the inverter when powering off and then powering on.  Setting range: 0.0 – 3600.0s (valid when P01.21=1)	1.0s	○
P01.23	Start delay time	The function determines the brake release after the running command is given, and the inverter is in a stand-by state and wait for the delay time set by P01.23 Setting range: 0.0 – 60.0s	0.0s	○
P01.24	Delay of stopping speed	Setting range: 0.0 – 100.0s	0.0s	○
P01.25	0Hz output	Select the 0Hz output of the inverter. 0: Output without voltage 1: Output with voltage 2: Output at the DC braking current	0	○
<b>P02 Group Motor 1</b>				
P02.01	Rated power of asynchronous motor	0.1 – 3000.0kW	Depend on model	◎
P02.02	Rated frequency of asynchronous motor	0.01Hz – P00.03	50.00Hz	◎
P02.03	Rated speed of asynchronous motor	1 – 36000rpm	Depend on model	◎
P02.04	Rated voltage of asynchronous motor	0 – 1200V	Depend on model	◎
P02.05	Rated current of asynchronous	0.8 – 6000.0A	Depend on model	◎

Function code	Name	Detailed instruction of parameters	Default value	Modify
	motor			
P02.06	Stator resistor of asynchronous motor	0.001 – 65.535Ω	Depend on model	○
P02.07	Rotor resistor of asynchronous motor	0.001 – 65.535Ω	Depend on model	○
P02.08	Leakage inductance of asynchronous motor	0.1 – 6553.5mH	Depend on model	○
P02.09	Mutual inductance of asynchronous motor	0.1 – 6553.5mH	Depend on model	○
P02.10	Non-load current of asynchronous motor	0.1 – 6553.5A	Depend on model	○
P02.11	Magnetic saturation coefficient 1 for the iron core of AM1	0.0 – 100.0%	80.0%	◎
P02.12	Magnetic saturation coefficient 2 for the iron core of AM1	0.0 – 100.0%	68.0%	◎
P02.13	Magnetic saturation coefficient 3 for the iron core of AM1	0.0 – 100.0%	57.0%	◎
P02.14	Magnetic saturation coefficient 4 for the iron core of AM1	0.0 – 100.0%	40.0%	◎
P02.26	Motor overload protection selection	0: No protection 1: Common motor (with low speed compensation). Because the heat-releasing effect of the common motors will be weakened, the corresponding electric heat protection will be adjusted properly. The low speed compensation characteristic mentioned here means reducing the threshold of the overload protection of the motor whose running frequency is below 30Hz.	2	◎

Function code	Name	Detailed instruction of parameters	Default value	Modify
		2: Frequency conversion motor (without low speed compensation). Because the heat-releasing of the specific motors won't be impacted by the rotation speed, it is not necessary to adjust the protection value during low-speed running.		
P02.27	Motor overload protection coefficient	<p>Times of motor overload <math>M = I_{out}/(I_n * K)</math></p> <p><math>I_n</math> is the rated current of the motor, <math>I_{out}</math> is the output current of the inverter and <math>K</math> is the motor protection coefficient.</p> <p>So, the bigger the value of <math>K</math> is, the smaller the value of <math>M</math> is. When <math>M = 116\%</math>, the fault will be reported after 1 hour, when <math>M = 200\%</math>, the fault will be reported after 1 minute, when <math>M &gt; 400\%</math>, the fault will be reported instantly.</p> <p>Setting range: 20.0% – 120.0%</p>	100.0%	○
P02.28	Correction coefficient of motor 1 power	<p>Correct the power displaying of motor 1.</p> <p>Only impact the displaying value other than the control performance of the inverter.</p> <p>Setting range: 0.00 – 3.00</p>	1.00	○
<b>P03 Group Vector control</b>				
P03.00	Speed loop proportional gain1	<p>The parameters P03.00 – P03.05 only apply to vector control mode. Below the switching frequency 1 (P03.02), the speed loop PI parameters are: P03.00 and P03.01. Above the switching frequency 2 (P03.05), the speed loop PI parameters are: P03.03 and P03.04. PI parameters are gained according to the linear change of two groups of parameters. It is shown as below:</p> <p>PI has a close relationship with the inertia of the system. Adjust on the base of PI according to different loads to meet various demands.</p> <p>The setting range of P03.00 and P03.03: 0 – 200.0</p> <p>The setting range of P03.01 and P03.04: 0.000 – 10.000s</p> <p>The setting range of P03.02: 0.00Hz – P00.05</p>	20.0	○
P03.01	Speed loop integral time1		0.200s	○
P03.02	Low switching frequency		5.00Hz	○
P03.03	Speed loop proportional gain 2		20.0	○
P03.04	Speed loop integral time 2		0.200s	○
P03.05	High switching frequency	10.00Hz	○	

Function code	Name	Detailed instruction of parameters	Default value	Modify
		The setting range of P03.05: P03.02 – P00.03		
P03.06	Speed loop output filter	0 – 8 (corresponds to 0 – 2 <sup>9</sup> /10ms)	0	○
P03.07	Compensation coefficient of vector control electromotion slip	Slip compensation coefficient is used to adjust the slip frequency of the vector control and improve the speed control accuracy of the system.	100%	○
P03.08	Compensation coefficient of vector control brake slip	Adjusting the parameter properly can control the speed steady-state error. Setting range: 50% – 200%	100%	○
P03.09	Current loop percentage coefficient P	<b>Note:</b> These two parameters adjust the PI adjustment parameter of the current loop which affects the dynamic response speed and control accuracy directly. Generally, users do not need to change the default value; Only apply to the vector control mode without PG 0 (P00.00=0). Setting range: 0 – 65535	1000	○
P03.10	Current loop integral coefficient I		1000	○
P03.11	Torque setting method	This parameter is used to enable the torque control mode, and set the torque setting means. 0: Torque control is invalid 1: Keypad setting torque (P03.12) 2: Analog AI1 setting torque 3: Analog AI2 setting torque 4: Analog AI3 setting torque 5: Pulse frequency HDI setting torque 6: Multi-step torque setting 7: MODBUS communication setting torque 8 – 10: Reserved <b>Note:</b> Setting mode 2 – 7, 100% corresponds to 3 times of the motor rated current	0	○
P03.12	Keypad setting torque	Setting range: -300.0% – 300.0% (motor rated current)	50.0%	○
P03.13	Torque given filter time	0.000 – 10.000s	0.100s	○
P03.14	Setting source of forward rotation upper-limit frequency in torque control	0: Keypad setting upper-limit frequency (P03.16 sets P03.14, P03.17 sets P03.15) 1: Analog AI1 setting upper-limit frequency 2: Analog AI2 setting upper-limit frequency 3: Analog AI3 setting upper-limit frequency 4: Pulse frequency HDI setting upper-limit frequency	0	○
P03.15	Setting source of reverse rotation upper-limit frequency in torque control	5: Multi-step setting upper-limit frequency 6: MODBUS communication setting upper-limit frequency 7 – 9: Reserved <b>Note:</b> setting method 1 – 9, 100% corresponds to	0	○

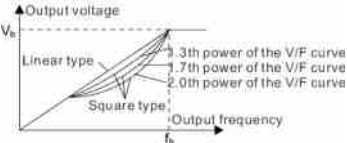

Function code	Name	Detailed instruction of parameters	Default value	Modify
		the maximum frequency		
P03.16	Torque control forward rotation upper-limit frequency keypad defined value	This function is used to set the upper limit of the frequency. P03.16 sets the value of P03.14; P03.17 sets the value of P03.15. Setting range: 0.00 Hz – P00.03 (the Max output frequency)	50.00 Hz	○
P03.17	Torque control reverse rotation upper-limit frequency keypad defined value		50.00 Hz	○
P03.18	Upper-limit setting of electromotion torque	This function code is used to select the electromotion and braking torque upper-limit setting source selection. 0: Keypad setting upper-limit frequency (P03.20 sets P03.18 and P03.21 sets P03.19)	0	○
P03.19	Upper-limit setting of braking torque	1: Analog AI1 setting upper-limit torque 2: Analog AI2 setting upper-limit torque 3: Analog AI3 setting upper-limit torque 4: Pulse frequency HDI setting upper-limit torque 5: MODBUS communication setting upper-limit torque 6 – 8: Reserved <b>Note:</b> Setting mode 1 – 8, 100% corresponds to three times of the motor current.	0	○
P03.20	Electromotion torque upper-limit keypad setting	The function code is used to set the limit of the torque. Setting range: 0.0 – 300.0% (motor rated current)	180.0%	○
P03.21	Braking torque upper-limit keypad setting		180.0%	○
P03.22	Weakening coefficient in constant power zone	The usage of motor in weakening control. Function code P03.22 and P03.23 are effective at constant power. The motor will enter into the weakening state when the motor runs at rated speed. Change the weakening curve by modifying the weakening control coefficient. The bigger the weakening control coefficient is, the steeper the weak curve is. The setting range of P03.22: 0.1 – 2.0 The setting range of P03.23: 10% – 100%	0.3	○
P03.23	The lowest weakening point in constant power zone		20%	○
P03.24	Max voltage limit	P03.24 set the max voltage of the inverter, which is dependent on the site situation. The setting range: 0.0 – 120.0%	100.0%	◎

Function code	Name	Detailed instruction of parameters	Default value	Modify
P03.25	Pre-exciting time	Pre-activate the motor when the inverter starts up. Build up a magnetic field inside the motor to improve the torque performance during the starting process. The setting time: 0.000 – 10.000s	0.300s	○
P03.26	Weakening proportional gain	0 – 8000	1200	○
P03.27	Speed display selection of vector control	0: Display at the actual value 1: Display at the setting value	0	○
<b>P04 Group SVPWM control</b>				
P04.00	V/F curve setting	<p>These function codes define the V/F curve of MSI20-EU motor 1 to meet the need of different loads.</p> <p>0: Straight line V/F curve; applying to the constant torque load 1: Multi-dots V/F curve 2: 1.3th power low torque V/F curve 3: 1.7th power low torque V/F curve 4: 2.0th power low torque V/F curve Curves 2 – 4 apply to the torque loads such as fans and water pumps. Users can adjust according to the features of the loads to get the best performance. 5: Customized V/F (V/F separation); in this mode, V can be separated from f and f can be adjusted through the frequency given channel set by P00.06 or the voltage given channel set by P04.27 to change the feature of the curve.</p> <p><b>Note:</b> <math>V_b</math> in the below picture is the motor rated voltage and <math>f_b</math> is the motor rated frequency.</p> 	0	◎
P04.01	Torque boost	Torque boost to the output voltage for the features of low frequency torque. P04.01 is for the Max output voltage $V_b$ .	0.0%	○
P04.02	Torque boost close	P04.02 defines the percentage of closing frequency of manual torque to $f_b$ . Torque boost should be selected according to the load. The bigger the load is, the bigger the torque is. Too big torque boost is inappropriate because the motor will run with over magnetic, and the current of the inverter will increase to add the temperature of the inverter and decrease the	20.0%	○

Function code	Name	Detailed instruction of parameters	Default value	Modify
		<p>efficiency.</p> <p>When the torque boost is set to 0.0%, the inverter is automatic torque boost.</p> <p>Torque boost threshold: below this frequency point, the torque boost is valid, but over this frequency point, the torque boost is invalid.</p> <p>The setting range of P04.01: 0.0%: (automatic) 0.1% – 10.0%</p> <p>The setting range of P04.02: 0.0% – 50.0%</p>		
P04.03	V/F frequency point 1	<p>When P04.00 = 1, the user can set V/F curve through P04.03 – P04.08.</p> <p>V/F is generally set according to the load of the motor.</p> <p><b>Note:</b> <math>V1 &lt; V2 &lt; V3</math>, <math>f1 &lt; f2 &lt; f3</math>. Too high low frequency voltage will heat the motor excessively or damage. Overcurrent stall or overcurrent protection may occur.</p> <p>The setting range of P04.03: 0.00Hz – P04.05</p> <p>The setting range of P04.04, P04.06 and P04.08 : 0.0% – 110.0% (rated motor voltage)</p> <p>The setting range of P04.05: P04.03 – P04.07</p> <p>The setting range of P04.07: P04.05 – P02.02 (rated motor voltage frequency)</p>	0.00Hz	○
P04.04	V/F voltage point 1		0.0%	○
P04.05	V/F frequency point 2		0.00Hz	○
P04.06	V/F voltage point 2		0.0%	○
P04.07	V/F frequency point 3		0.00Hz	○
P04.08	V/F voltage point 3	<p>This function code is used to compensate the change of the rotation speed caused by load during compensation SVPWM control to improve the rigidity of the motor. It can be set to the rated slip frequency of the motor which is counted as below:</p> <p><math>\Delta f = f_b - n * p / 60</math></p> <p>Of which, <math>f_b</math> is the rated frequency of the motor, its function code is P02.02; <math>n</math> is the rated rotating speed of the motor and its function code is P02.03; <math>p</math> is the pole pair of the motor. 100.0% corresponds to the rated slip frequency <math>\Delta f</math>.</p> <p>Setting range: 0.0 – 200.0%</p>	0.0%	○
P04.09	V/F slip compensation gain	<p>This function code is used to compensate the change of the rotation speed caused by load during compensation SVPWM control to improve the rigidity of the motor. It can be set to the rated slip frequency of the motor which is counted as below:</p> <p><math>\Delta f = f_b - n * p / 60</math></p> <p>Of which, <math>f_b</math> is the rated frequency of the motor, its function code is P02.02; <math>n</math> is the rated rotating speed of the motor and its function code is P02.03; <math>p</math> is the pole pair of the motor. 100.0% corresponds to the rated slip frequency <math>\Delta f</math>.</p> <p>Setting range: 0.0 – 200.0%</p>	100.0%	○

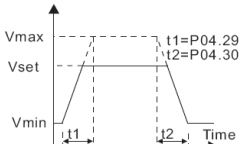
Function code	Name	Detailed instruction of parameters	Default value	Modify
P04.10	Low frequency vibration control factor	In the SVPWM control mode, current fluctuation may occur to the motor on some frequency, especially the motor with big power. The motor cannot run stably or overcurrent may occur. These phenomena can be canceled by adjusting this parameter.	10	○
P04.11	High frequency vibration control factor	The setting range of P04.10: 0 – 100	10	○
P04.12	Vibration control threshold	The setting range of P04.11: 0 – 100 The setting range of P04.12: 0.00Hz – P00.03 (the Max frequency)	30.00 Hz	○
P04.26	Energy-saving operation selection	0: No operation 1: Automatic energy-saving operation Motor on the light load conditions, automatically adjusts the output voltage to save energy	0	◎
P04.27	Voltage Setting channel	Select the output setting channel at V/F curve separation. 0: Keypad setting voltage: the output voltage is determined by P04.28. 1: AI1 setting voltage 2: AI2 setting voltage 3: AI3 setting voltage 4: HDI setting voltage 5: Multi-step speed setting voltage; 6: PID setting voltage; 7: MODBUS communication setting voltage; 8 – 10: Reversed <b>Note:</b> 100% corresponds to the rated voltage of the motor.	0	○
P04.28	Keypad setting voltage	The function code is the voltage digital set value when the voltage setting channel is selected as "keypad selection" The setting range: 0.0% – 100.0%	100.0%	○
P04.29	Voltage increasing time	Voltage increasing time is the time when the inverter accelerates from the output minimum voltage to the output maximum voltage.	5.0s	○
P04.30	Voltage decreasing time	Voltage decreasing time is the time when the inverter decelerates from the output maximum voltage to the output minimum voltage. The setting range: 0.0 – 3600.0s	5.0s	○
P04.31	Output maximum voltage	Set the upper and low limit of the output voltage. The setting range of P04.31: P04.32 – 100.0% (the rated voltage of the motor)	100.0%	◎
P04.32	Output minimum voltage	The setting range of P04.32: 0.0% – P04.31 (the rated voltage of the motor) 	0.0%	◎

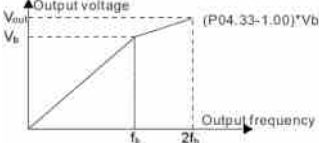
Function code	Name	Detailed instruction of parameters	Default value	Modify
P04.33	Weakening coefficient in constant power zone	Adjust the output voltage of the inverter in SVPWM mode when weakening. <b>Note:</b> Invalid in the constant torque mode.  The setting range of P04.33: 1.00 – 1.30	1.00	○
<b>P05 Group Input terminals</b>				
P05.00	HDI input selection	0: HDI is high pulse input. See P05.49 – P05.54 1: HDI is switch input	0	◎
P05.01	S1 terminals function selection	<b>Note:</b> S1 – S4, HDI are the upper terminals on the control board and P05.12 can be used to set the function of S5 – S8 0: No function	1	◎
P05.02	S2 terminals function selection		1: Forward rotation operation 2: Reverse rotation operation 3: 3-wire control operation	4
P05.03	S3 terminals function selection	4: Forward jogging 5: Reverse jogging 6: Coast to stop	7	◎
P05.04	S4 terminals function selection	7: Fault reset 8: Operation pause 9: External fault input	0	◎
P05.05	S5 terminals function selection	10: Increasing frequency setting (UP) 11: Decreasing frequency setting (DOWN) 12: Cancel the frequency change setting 13: Shift between A setting and B setting	0	◎
P05.06	S6 terminals function selection	14: Shift between combination setting and A setting 15: Shift between combination setting and B setting	0	◎
P05.07	S7 terminals function selection	16: Multi-step speed terminal 1 17: Multi-step speed terminal 2 18: Multi-step speed terminal 3	0	◎
P05.08	S8 terminals function selection	19: Multi- stage speed terminal 4 20: Multi- stage speed pause 21: ACC/DEC time 1 22: ACC/DEC time 2	0	◎
P05.09	HDI terminals function selection	23: Simple PLC stop reset 24: Simple PLC pause 25: PID control pause 26: Traverse Pause (stop at the current frequency) 27: Traverse reset (return to the center frequency) 28: Counter reset 29: Torque control prohibition 30: ACC/DEC prohibition 31: Counter trigger	0	◎

Function code	Name	Detailed instruction of parameters	Default value	Modify																				
		32: Reserve 33: Cancel the frequency change setting temporarily 34: DC brake 35: Reserve 36: Shift the command to the keypad 37: Shift the command to the terminals 38: Shift the command to the communication 39: Pre-magnetized command 40: Clear the power 41: Keep the power 42 – 60: Reserved 61: PID pole switching 62 – 63: Reserved																						
P05.10	Polarity selection of the input terminals	The function code is used to set the polarity of the input terminals. Set the bit to 0, the input terminal is anode. Set the bit to 1, the input terminal is cathode. <table border="1" style="margin: 10px auto;"> <tr> <td>BIT8</td><td>BIT7</td><td>BIT6</td><td>BIT5</td><td>BIT4</td></tr> <tr> <td>HDI</td><td>S8</td><td>S7</td><td>S6</td><td>S5</td></tr> <tr> <td>BIT3</td><td>BIT2</td><td>BIT1</td><td>BIT0</td><td></td></tr> <tr> <td>S4</td><td>S3</td><td>S2</td><td>S1</td><td></td></tr> </table> The setting range: 0x000 – 0x1FF	BIT8	BIT7	BIT6	BIT5	BIT4	HDI	S8	S7	S6	S5	BIT3	BIT2	BIT1	BIT0		S4	S3	S2	S1		0x000	○
BIT8	BIT7	BIT6	BIT5	BIT4																				
HDI	S8	S7	S6	S5																				
BIT3	BIT2	BIT1	BIT0																					
S4	S3	S2	S1																					
P05.11	Switch filter time	Set the sample filter time of S1 – S4 and HDI terminals. If the interference is strong, increase the parameter to avoid wrong operation. 0.000 – 1.000s	0.010s	○																				
P05.12	Virtual terminals setting	0x000 – 0x1FF (0: Disabled, 1: Enabled ) BIT0: S1 virtual terminal BIT1: S2 virtual terminal BIT2: S3 virtual terminal BIT3: S4 virtual terminal BIT4: S5 virtual terminal BIT5: S6 virtual terminal BIT6: S7 virtual terminal BIT7: S8 virtual terminal BIT8: HDI virtual terminal	0x000	◎																				
P05.13	Terminals control running mode	Set the operation mode of the terminals control 0: 2-wire control; 1: comply the enable with the direction. This mode is widely used. It determines the rotation direction by the defined FWD and REV terminals command. <div style="display: flex; align-items: center; margin: 10px 0;"> <table border="1" style="font-size: small;"> <thead> <tr> <th>FWD</th> <th>REV</th> <th>Running command</th> </tr> </thead> <tbody> <tr> <td>OFF</td> <td>OFF</td> <td>Stopping</td> </tr> <tr> <td>ON</td> <td>OFF</td> <td>Forward running</td> </tr> <tr> <td>OFF</td> <td>ON</td> <td>Reverse running</td> </tr> <tr> <td>ON</td> <td>ON</td> <td>Hold on</td> </tr> </tbody> </table> </div> 1: 2-wire control 2; Separate the enable from the	FWD	REV	Running command	OFF	OFF	Stopping	ON	OFF	Forward running	OFF	ON	Reverse running	ON	ON	Hold on	0	◎					
FWD	REV	Running command																						
OFF	OFF	Stopping																						
ON	OFF	Forward running																						
OFF	ON	Reverse running																						
ON	ON	Hold on																						

Function code	Name	Detailed instruction of parameters	Default value	Modify																																																					
		<p>direction. FWD defined by this mode is the enabling ones. The direction depends on the state of the defined REV.</p> <table border="1" style="margin-left: 100px;"> <tr><td>FWD</td><td>REV</td><td>Running command</td></tr> <tr><td>OFF</td><td>OFF</td><td>Stopping</td></tr> <tr><td>ON</td><td>OFF</td><td>Forward running</td></tr> <tr><td>OFF</td><td>ON</td><td>Stopping</td></tr> <tr><td>ON</td><td>ON</td><td>Reverse running</td></tr> </table> <p>2: 3-wire control 1; SIn is the enabling terminal on this mode, and the running command is caused by FWD and the direction is controlled by REV. SIn is natural closed.</p> <p>The direction control is as below during operation:</p> <table border="1" style="margin-left: 100px;"> <thead> <tr> <th>SIn</th> <th>REV</th> <th>Previous direction</th> <th>Current direction</th> </tr> </thead> <tbody> <tr> <td rowspan="2">ON</td> <td rowspan="2">OFF→ON</td> <td>Forward</td> <td>Reverse</td> </tr> <tr> <td>Reverse</td> <td>Forward</td> </tr> <tr> <td rowspan="2">ON</td> <td rowspan="2">ON→OFF</td> <td>Reverse</td> <td>Forward</td> </tr> <tr> <td>Forward</td> <td>Reverse</td> </tr> <tr> <td>ON→OFF</td> <td>ON</td> <td colspan="2" rowspan="2">Decelerate to stop</td> </tr> <tr> <td></td> <td>OFF</td> </tr> </tbody> </table> <p>3: 3-wire control 2; SIn is the enabling terminal on this mode, and the running command is caused by SB1 or SB3 and both of them control the running direction. NC SB2 generates the stop command.</p> <table border="1" style="margin-left: 100px;"> <thead> <tr> <th>SIn</th> <th>FWD</th> <th>REV</th> <th>Direction</th> </tr> </thead> <tbody> <tr> <td rowspan="2">ON</td> <td rowspan="2">OFF→ON</td> <td>ON</td> <td>Forward</td> </tr> <tr> <td>OFF</td> <td>Reverse</td> </tr> <tr> <td rowspan="2">ON</td> <td>ON</td> <td rowspan="2">OFF→ON</td> <td>Forward</td> </tr> <tr> <td>OFF</td> <td>Reverse</td> </tr> </tbody> </table>	FWD	REV	Running command	OFF	OFF	Stopping	ON	OFF	Forward running	OFF	ON	Stopping	ON	ON	Reverse running	SIn	REV	Previous direction	Current direction	ON	OFF→ON	Forward	Reverse	Reverse	Forward	ON	ON→OFF	Reverse	Forward	Forward	Reverse	ON→OFF	ON	Decelerate to stop			OFF	SIn	FWD	REV	Direction	ON	OFF→ON	ON	Forward	OFF	Reverse	ON	ON	OFF→ON	Forward	OFF	Reverse		
FWD	REV	Running command																																																							
OFF	OFF	Stopping																																																							
ON	OFF	Forward running																																																							
OFF	ON	Stopping																																																							
ON	ON	Reverse running																																																							
SIn	REV	Previous direction	Current direction																																																						
ON	OFF→ON	Forward	Reverse																																																						
		Reverse	Forward																																																						
ON	ON→OFF	Reverse	Forward																																																						
		Forward	Reverse																																																						
ON→OFF	ON	Decelerate to stop																																																							
	OFF																																																								
SIn	FWD	REV	Direction																																																						
ON	OFF→ON	ON	Forward																																																						
		OFF	Reverse																																																						
ON	ON	OFF→ON	Forward																																																						
	OFF		Reverse																																																						

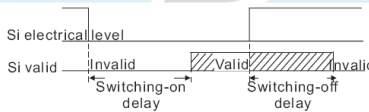
Function code	Name	Detailed instruction of parameters	Default value	Modify								
		<table border="1" style="width: 100%; border-collapse: collapse;"> <tr> <td style="width: 30%;">ON→</td> <td style="width: 20%;"></td> <td style="width: 20%;"></td> <td style="width: 30%;">Decelerate to stop</td> </tr> <tr> <td>OFF</td> <td></td> <td></td> <td></td> </tr> </table> <p><b>Note:</b> for the 2-wire running mode, when FWD/REV terminal is valid, the inverter stop because of the stopping command from other sources, even the control terminal FWD/REV keeps valid; the inverter won't work when the stopping command is canceled. Only when FWD/REV is relaunched, the inverter can start again. For example, the valid STOP/RST stop when PLC signal cycles stop, fixed-length stop and terminal control (see P07.04).</p>	ON→			Decelerate to stop	OFF					
ON→			Decelerate to stop									
OFF												
P05.14	S1 terminal switching on delay time		0.000s	○								
P05.15	S1 terminal switching off delay time		0.000s	○								
P05.16	S2 terminal switching on delay time		0.000s	○								
P05.17	S2 terminal switching off delay time		0.000s	○								
P05.18	S3 terminal switching on delay time	The function code defines the corresponding delay time of electrical level of the programmable terminals from switching on to switching off.	0.000s	○								
P05.19	S3 terminal switching off delay time		0.000s	○								
P05.20	S4 terminal switching on delay time	Setting range: 0.000 – 50.000s	0.000s	○								
P05.21	S4 terminal switching off delay time		0.000s	○								
P05.30	HDI terminal switching on delay time		0.000s	○								
P05.31	HDI terminal switching off delay time		0.000s	○								
P05.32	Lower limit of AI1	AI1 is set by the analog potentiometer, AI2 is set by control terminal AI2 and AI3 is set by control	0.00V	○								

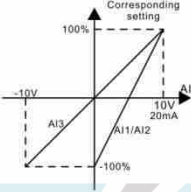

Function code	Name	Detailed instruction of parameters	Default value	Modify
P05.33	Corresponding setting of the lower limit of AI1	terminal AI3. The function code defines the relationship between the analog input voltage and its corresponding set value. If the analog input voltage beyond the set minimum or maximum input value, the inverter will count at the minimum or maximum one.	0.0%	○
P05.34	Upper limit of AI1		10.00V	○
P05.35	Corresponding setting of the upper limit of AI1	When the analog input is the current input, the corresponding voltage of 0 – 20mA is 0 – 10V. In different cases, the corresponding rated value of 100.0% is different. See the application for detailed information.	100.0%	○
P05.36	AI1 input filter time	The figure below illustrates different applications:	0.100s	○
P05.37	Lower limit of AI2		0.00V	○
P05.38	Corresponding setting of the lower limit of AI2		0.0%	○
P05.39	Upper limit of AI2		10.00V	○
P05.40	Corresponding setting of the upper limit of AI2	Input filter time: this parameter is used to adjust the sensitivity of the analog input. Increasing the value properly can enhance the anti-interference of the analog, but weaken the sensitivity of the analog input	100.0%	○
P05.41	AI2 input filter time	<b>Note:</b> AI1 supports 0 – 10V input and AI2 supports 0 – 10V or 0 – 20mA input, when AI2 selects 0 – 20mA input, the corresponding voltage of 20mA is 10V. AI3 can support the output of -10V – +10V.	0.100s	○
P05.42	Lower limit of AI3	The setting range of P05.32: 0.00V – P05.34 The setting range of P05.33: -100.0% – 100.0% The setting range of P05.34: P05.32 – 10.00V	-10.00V	○
P05.43	Corresponding setting of the lower limit of AI3	The setting range of P05.35: -100.0% – 100.0% The setting range of P05.36: 0.000s – 10.000s	-100.0%	○
P05.44	Middle value of AI3	The setting range of P05.37: 0.00V – P05.39 The setting range of P05.38: -100.0% – 100.0% The setting range of P05.39: P05.37 – 10.00V	0.00V	○
P05.45	Corresponding middle setting of AI3	The setting range of P05.40: -100.0% – 100.0% The setting range of P05.41: 0.000s – 10.000s	0.0%	○
P05.46	Upper limit of AI3	The setting range of P05.42: -10.00V – P05.44 The setting range of P05.43: -100.0% – 100.0% The setting range of P05.44: P05.42 – P05.46	10.00V	○
P05.47	Corresponding setting of the upper limit of AI3	The setting range of P05.45: -100.0% – 100.0% The setting range of P05.46: P05.44 – 10.00V	100.0%	○
P05.48	AI3 input filter time	The setting range of P05.48: 0.000s – 10.000s	0.100s	○
P05.50	Lower limit frequency of HDI	0.000kHz – P05.52	0.000 kHz	○
P05.51	Corresponding setting of HDI	-100.0% – 100.0%	0.0%	○

Function code	Name	Detailed instruction of parameters	Default value	Modify								
	low frequency setting											
P05.52	Upper limit frequency of HDI	P05.50 – 50.000kHz	50.000 kHz	○								
P05.53	Corresponding setting of upper limit frequency of HDI	-100.0% – 100.0%	100.0%	○								
P05.54	HDI frequency input filter time	0.000s – 10.000s	0.100s	○								
<b>P06 Group Output terminals</b>												
P06.01	Y1 output selection	0: Invalid 1: In operation	27									
P06.03	Relay RO1 output selection	2: Forward rotation operation 3: Reverse rotation operation 4: Jogging operation 5: The inverter fault	1	○								
P06.04	Relay RO2 output selection	6: Frequency degree test FDT1 7: Frequency degree test FDT2 8: Frequency arrival 9: Zero speed running 10: Upper limit frequency arrival 11: Lower limit frequency arrival 12: Ready for operation 13: Pre-magnetizing 14: Overload pre-alarm 15: Underload pre-alarm 16: Completion of simple PLC stage 17: Completion of simple PLC cycle 18: Setting count value arrival 19: Defined count value arrival 20: External fault valid 21: Reserved 22: Running time arrival 23: MODBUS communication virtual terminals output 24 – 25: Reserved 26: Establishment of DC bus voltage 27: STO action 28 – 30: Reserved	5	○								
P06.05	Polarity selection of output terminals	The function code is used to set the pole of the output terminal. When the current bit is set to 0, input terminal is positive. When the current bit is set to 1, input terminal is negative.	0	○								
		<table border="1"> <tr> <td>BIT3</td> <td>BIT2</td> <td>BIT1</td> <td>BIT0</td> </tr> <tr> <td>RO2</td> <td>RO1</td> <td>Reserved</td> <td>Y1</td> </tr> </table>	BIT3	BIT2	BIT1	BIT0	RO2	RO1	Reserved	Y1		
BIT3	BIT2	BIT1	BIT0									
RO2	RO1	Reserved	Y1									

Function code	Name	Detailed instruction of parameters	Default value	Modify
		Setting range: 0 – F		
P06.06	Y1 open delay time	The setting range: 0.000 – 50.000s	0.000s	○
P06.07	Y1C off delay time	The setting range: 0.000 – 50.000s	0.000s	○
P06.10	RO1 switching on delay time	The function code defines the corresponding delay time of the electrical level change during the programmable terminal switching on and off.	0.000s	○
P06.11	RO1 switching off delay time		0.000s	○
P06.12	RO2 switching on delay time		0.000s	○
P06.13	RO2 switching off delay time		0.000s	○
P06.14	AO1 output selection	0: Running frequency 1: Setting frequency 2: Ramp reference frequency 3: Running rotation speed 4: Output current (relative to 2 times of the rated current of the inverter) 5: Output current (relative to 2 times of the rated current of the motor) 6: Output voltage 7: Output power 8: Set torque value 9: Output torque 10: Analog AI1 input value 11: Analog AI2 input value 12: Analog AI3 input value 13: High speed pulse HDI input value 14: MODBUS communication set value 1 15: MODBUS communication set value 2 16 – 21: Reserved 22: Torque current (corresponds to 3 times of the rated current of the motor) 23: Ramp reference frequency (with sign) 24 – 30: Reserved	0	○
P06.15	AO2 output selection		0	○
P06.17	Lower limit of AO1 output	The above function codes define the relative relationship between the output value and analog output. When the output value exceeds the range of set maximum or minimum output, it will count according to the low-limit or upper-limit output.	0.0%	○
P06.18	Corresponding AO1 output to the lower limit		0.00V	○
P06.19	Upper limit of AO1 output	When the analog output is current output, 1mA equals to 0.5V.	100.0%	○
P06.20	The corresponding AO1 output to the upper limit	In different cases, the corresponding analog output of 100% of the output value is different. Please refer to each application for detailed information.	10.00V	○

Function code	Name	Detailed instruction of parameters	Default value	Modify	
P06.21	AO1 output filter time		0.000s	○	
P06.22	Lower limit of AO2 output		0.0%	○	
P06.23	Corresponding AO2 output to the lower limit		Setting range of P06.17: -100.0% – P06.19 Setting range of P06.18: 0.00V – 10.00V	0.00V	○
P06.24	Upper limit of AO2 output		Setting range of P06.19: P06.17 – 100.0% Setting range of P06.20: 0.00V – 10.00V	100.0%	○
P06.25	Corresponding AO2 output to the upper limit		Setting range of P06.21: 0.000s – 10.000s Setting range of P06.22: 100.0% – P06.24 Setting range of P06.23: 0.00V – 10.00V	10.00V	○
P06.26	AO2 output filter time		Setting range of P06.24: P06.22 – 100.0% Setting range of P06.25: 0.00V – 10.00V Setting range of P06.26: 0.000s – 10.000s	0.000s	○
<b>P07 Group Human-Machine Interface</b>					
P07.00	User's password	0 – 65535 The password protection will be valid when setting any non-zero number. 00000: Clear the previous user's password, and make the password protection invalid. After the user's password becomes valid, if the password is incorrect, users cannot enter the parameter menu. Only correct password can make the user check or modify the parameters. Please remember all users' passwords. Retreat editing state of the function codes and the password protection will become valid in 1 minute. If the password is available, press <b>PRG/ESC</b> to enter into the editing state of the function codes, and then "0.0.0.0.0" will be displayed. Unless input right password, the operator cannot enter into it. <b>Note:</b> Restoring to the default value can clear the password, please use it with caution.	0	○	
P07.01	Parameter copy	0: No operation 1: Upload the local function parameter to the keypad 2: Download the keypad function parameter to local address (including the motor parameters) 3: Download the keypad function parameter to local address (excluding the motor parameter of P02 and P12 group) 4: Download the keypad function parameters to local address (only for the motor parameter of P02 and P12 group) <b>Note:</b> After finish 1 – 4, the parameter will restore	0	⊙	

Function code	Name	Detailed instruction of parameters	Default value	Modify
		to 0 and the uploading and downloading does not include P29.		
P07.02	Key function selection	<p>0x00 – 0x27</p> <p>Ones: <b>QUICK/JOG</b> key function</p> <p>0: Null</p> <p>1: Jogging</p> <p>2: Switch display state via shift key</p> <p>3: Switch between FWD/REV rotation</p> <p>4: Clear UP/DOWN setting</p> <p>5: Coast to stop</p> <p>6: Switch running command ref. mode in order</p> <p>7: Quick commission mode (based on non-default parameter)</p> <p>tens:</p> <p>0: keys unlocked</p> <p>1: Lock all keys</p> <p>2: Lock part of the keys (lock <b>PRG/ESC</b> key only)</p>	0x01	⊙
P07.03	<b>QUICK/JOG</b> the shifting sequence of running command	<p>When P07.02=6, set the shifting sequence of running command channels.</p> <p>0: Keypad control→terminals control →communication control</p> <p>1: Keypad control←→terminals control</p> <p>2: Keypad control←→communication control</p> <p>3: Terminals control←→communication control</p>	0	○
P07.04	<b>STOP/RST</b> stop function	<p>Select the stop function by <b>STOP/RST</b>.</p> <p><b>STOP/RST</b> is effective in any state for the keypad reset.</p> <p>0: Only valid for the keypad control</p> <p>1: Both valid for keypad and terminals control</p> <p>2: Both valid for keypad and communication control</p> <p>3: Valid for all control modes</p>	0	○
P07.05	Displayed parameters 1 of running state	<p>0x0000 – 0xFFFF</p> <p>BIT0: running frequency (Hz on)</p> <p>BIT1: set frequency (Hz flickering)</p> <p>BIT2: bus voltage (Hz on)</p> <p>BIT3: output voltage (V on)</p> <p>BIT4: output current (A on)</p> <p>BIT5: running rotation speed (rpm on)</p> <p>BIT6: output power (% on)</p> <p>BIT7: output torque (% on)</p> <p>BIT8: PID reference (% flickering)</p> <p>BIT9: PID feedback value (% on)</p> <p>BIT10: input terminals state</p> <p>BIT11: output terminals state</p> <p>BIT12: torque set value (% on)</p> <p>BIT13: pulse counter value</p>	0x03FF	○

Function code	Name	Detailed instruction of parameters	Default value	Modify
		BIT14: reserved BIT15: PLC and the current step of multi-step speed		
P07.06	Displayed parameters 2 of running state	0x0000 – 0xFFFF BIT0: analog AI1 value (V on) BIT1: analog AI2 value (V on) BIT2: analog AI3 value (V on) BIT3: high speed pulse HDI frequency BIT4: motor overload percentage (% on) BIT5: the inverter overload percentage (% on) BIT6: ramp frequency given value (Hz on) BIT7: linear speed BIT8: AC inlet current (A on) BIT9 – 15: reserved	0x0000	
P07.07	The parameter selection of the stop state	0x0000 – 0xFFFF BIT0: set frequency (Hz on, frequency flickering slowly) BIT1: bus voltage (V on) BIT2: input terminals state BIT3: output terminals state BIT4: PID reference (% flickering) BIT5: PID feedback value (% flickering) BIT6: torque reference (% flickering) BIT7: analog AI1 value (V on) BIT8: analog AI2 value (V on) BIT9: analog AI3 value (V on) BIT10: high speed pulse HDI frequency BIT11: PLC and the current step of multi-step speed BIT12: pulse counters BIT13 – BIT15: reserved	0x00FF	○
P07.08	Frequency display coefficient	0.01 – 10.00 Displayed frequency=running frequency* P07.08	1.00	○
P07.09	Speed display coefficient	0.1 – 999.9% Mechanical rotation speed =120*displayed running frequency×P07.09/motor pole pairs	100.0%	○
P07.10	Linear speed displayed coefficient	0.1 – 999.9% Linear speed= Mechanical rotation speed×P07.10	1.0%	○
P07.11	Rectifier bridge module temperature	-20.0 – 120.0°C		●
P07.12	Converter module temperature	-20.0 – 120.0°C		●
P07.13	Software version	1.00 – 655.35		●
P07.14	Local accumulative	0 – 65535h		●

Function code	Name	Detailed instruction of parameters	Default value	Modify
	running time			
P07.15	High bit of power consumption	Display the power used by the inverter. The power consumption of the inverter =P07.15*1000+P07.16		•
P07.16	Low bit of power consumption	Setting range of P07.15: 0 – 65535 kWh (*1000) Setting range of P07.16: 0.0 – 999.9 kWh		•
P07.17	Reserved	Reserved		•
P07.18	Rated power of the inverter	0.4 – 3000.0kW		•
P07.19	Rated voltage of the inverter	50 – 1200V		•
P07.20	Rated current of the inverter	0.1 – 6000.0A		•
P07.21	Factory bar code 1	0x0000 – 0xFFFF		•
P07.22	Factory bar code 2	0x0000 – 0xFFFF		•
P07.23	Factory bar code 3	0x0000 – 0xFFFF		•
P07.24	Factory bar code 4	0x0000 – 0xFFFF		•
P07.25	Factory bar code 5	0x0000 – 0xFFFF		•
P07.26	Factory bar code 6	0x0000 – 0xFFFF		•
P07.27	Current fault type	0: No fault 1: OUt1 2: OUt2 3: OUt3 4: OC1 5: OC2 6: OC3 7: OV1 8: OV2 9: OV3 10: UV 11: Motor overload (OL1) 12: The inverter overload (OL2) 13: Input side phase loss (SPI) 14: Output side phase loss (SPO) 15: Overheat of the rectifier module (OH1) 16: Overheat fault of the inverter module (OH2) 17: External fault (EF)		•

Function code	Name	Detailed instruction of parameters	Default value	Modify
P07.28	Previous fault type	18: 485 communication fault (CE) 19: Current detection fault (ItE) 20: Motor autotune fault (tE) 21: EEPROM operation fault (EEP) 22: PID response offline fault (PIDE) 23: bCE 24: Running time arrival (END) 25: Electrical overload (OL3) 26: PCE 27: UPE 28: DNE 29 – 31: Reserved 32: ETH1 33: ETH2 34: Speed deviation fault (dEu)		•
P07.29	Previous 2 fault type	35: Maladjustment (STo) 36: Underload fault (LL)		•
P07.30	Previous 3 fault type	37: Safe torque stop (STO) 38: Channel 1 is abnormal (STL1) 39: Channel 2 is abnormal (STL2)		•
P07.31	Previous 4 fault type	40: Channel H1 and H2 become abnormal simultaneously (STL3)		•
P07.32	Previous 5 fault type	41: Safety code FLASH CRC check fault (CrCE)		•
P07.33	Current fault running frequency		0.00Hz	•
P07.34	Ramp reference frequency at current fault		0.00Hz	
P07.35	Output voltage at the current fault		0V	
P07.36	Output current at the current fault		0.0A	
P07.37	Current bus voltage at the current fault		0.0V	
P07.38	The Max temperature at the current fault		0.0°C	
P07.39	Input terminals state at the current fault		0	•
P07.40	Output terminals state at the current fault		0	•
P07.41	Reference frequency at previous fault		0.00Hz	•
P07.42	Ramp reference frequency at previous fault		0.00Hz	•
P07.43	Output voltage at previous fault		0V	•
P07.44	The output current at previous fault		0.0A	•
P07.45	Bus voltage at previous fault		0.0V	•
P07.46	The Max temperature at previous fault		0.0°C	•
P07.47	Input terminals state at previous fault		0	•
P07.48	Output terminals state at previous fault		0	•
P07.49	Reference frequency at previous 2 faults		0.00Hz	•
P07.50	Ramp reference frequency at previous 2 faults		0.00Hz	•
P07.51	Output voltage at previous 2 faults		0V	•
P07.52	Output current at previous 2 faults		0.0A	•
P07.53	Bus voltage at previous 2 faults		0.0V	•
P07.54	The Max temperature at previous 2 faults		0.0°C	•
P07.55	Input terminals state at previous 2 faults		0	•
P07.56	Output terminals state at previous 2 faults		0	•
<b>P08 Group Enhanced functions</b>				
P08.00	ACC time 2	Refer to P00.11 and P00.12 for detailed definition.	Depend	○

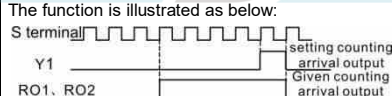

Function code	Name	Detailed instruction of parameters	Default value	Modify
P08.01	DEC time 2	MSI20-EU series define four groups of ACC/DEC time which can be selected by P5 group. The first group of ACC/DEC time is the factory default one. Setting range: 0.0 – 3600.0s	on	<input type="radio"/>
P08.02	ACC time 3		model	<input type="radio"/>
P08.03	DEC time 3		<input type="radio"/>	<input type="radio"/>
P08.04	ACC time 4		<input type="radio"/>	<input type="radio"/>
P08.05	DEC time 4		<input type="radio"/>	<input type="radio"/>
P08.06	Jogging running frequency	This parameter is used to define the reference frequency during jogging. Setting range: 0.00Hz – P00.03 (the max frequency)	5.00Hz	<input type="radio"/>
P08.07	Jogging running ACC time	The jogging ACC time means the time needed if the inverter runs from 0Hz to the max frequency. The jogging DEC time means the time needed if the inverter goes from the max frequency (P00.03) to 0Hz. Setting range: 0.0 – 3600.0s	Depend on model	<input type="radio"/>
P08.08	Jogging running DEC time			<input type="radio"/>
P08.09	Jumping frequency 1	<p>When the set frequency is in the range of jumping frequency, the inverter will run at the edge of the jumping frequency.</p> <p>The inverter can avoid the mechanical resonance point by setting the jumping frequency. The inverter can set three jumping frequency. But this function will be invalid if all jumping points are 0.</p>	0.00Hz	<input type="radio"/>
P08.10	jumping frequency range 1		0.00Hz	<input type="radio"/>
P08.11	Jumping frequency 2		0.00Hz	<input type="radio"/>
P08.12	Jumping frequency range 2		0.00Hz	<input type="radio"/>
P08.13	Jumping frequency 3		0.00Hz	<input type="radio"/>
P08.14	Jumping frequency range 3	0.00Hz	<input type="radio"/>	
P08.15	Traverse range	This function applies to the industries where traverse and convolution function are required such as textile and chemical fiber. The traverse function means that the output frequency of the inverter is fluctuated with the set frequency as its center. The route of the running frequency is illustrated as below, of which the traverse is set by P08.15 and when P08.15 is set as 0, the traverse is 0 with no function.	0.0%	<input type="radio"/>
P08.16	Sudden jumping frequency range		0.0%	<input type="radio"/>
P08.17	Traverse boost time		5.0s	<input type="radio"/>
P08.18	Traverse declining time	<p>Traverse range: The traverse running is limited by upper and low frequency.</p>	5.0s	<input type="radio"/>

Function code	Name	Detailed instruction of parameters	Default value	Modify
		<p>The traverse range relative to the center frequency: traverse range <math>AW = \text{center frequency} \times \text{traverse range}</math> P08.15.</p> <p>Sudden jumping frequency = traverse range <math>AW \times \text{sudden jumping frequency range}</math> P08.16.</p> <p>When run at the traverse frequency, the value which is relative to the sudden jumping frequency.</p> <p>The raising time of the traverse frequency: The time from the lowest point to the highest one.</p> <p>The declining time of the traverse frequency: The time from the highest point to the lowest one.</p> <p>The setting range of P08.15: 0.0 – 100.0% (relative to the set frequency)</p> <p>The setting range of P08.16: 0.0 – 50.0% (relative to the traverse range)</p> <p>The setting range of P08.17: 0.1 – 3600.0s</p> <p>The setting range of P08.18: 0.1 – 3600.0s</p>		
P08.25	Setting counting value	The counter works by the input pulse signals of the HDI terminals.	0	○
P08.26	Given counting value	<p>When the counter achieves a fixed number, the multi-function output terminals will output the signal of "fixed counting number arrival" and the counter go on working; when the counter achieves a setting number, the multi-function output terminals will output the signal of "setting counting number arrival", the counter will clear all numbers and stop to recount before the next pulse.</p> <p>The setting counting value P08.26 should be no more than the setting counting value P08.25.</p> <p>The function is illustrated as below:</p>  <p>Setting range of P08.25: P08.26 – 65535</p> <p>Setting range of P08.26: 0 – P08.25</p>	0	○
P08.27	Setting running time	Pre-set running time of the inverter. When the accumulative running time achieves the set time, the multi-function digital output terminals will output the signal of "running time arrival". Setting range: 0 – 65535min	0m	○
P08.28	Time of fault reset	The time of the fault reset: set the fault reset time by selecting this function. If the reset time exceeds this set value, the inverter will stop for the fault and wait to be repaired.	0	○
P08.29	Interval time of automatic fault reset	The interval time of the fault reset: The interval between the time when the fault occurs and the time when the reset action occurs. Setting range of P08.28: 0 – 10 Setting range of P08.29: 0.1 – 100.0s	1.0s	○
P08.30	Frequency	The output frequency of the inverter changes as	0.00Hz	○

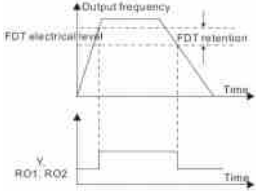
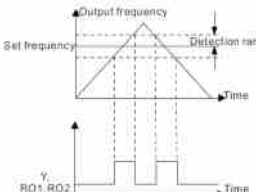
Function code	Name	Detailed instruction of parameters	Default value	Modify
	decreasing ratio in drop control	the load. And it is mainly used to balance the power when several inverters drive one load. Setting range: -50.00Hz – 50.00Hz		
P08.32	FDT1 electrical level detection value	When the output frequency exceeds the corresponding frequency of FDT electrical level, the multi-function digital output terminals will output the signal of “frequency level detect FDT” until the output frequency decreases to a value lower than (FDT electrical level—FDT retention detection value) the corresponding frequency, the signal is invalid. Below is the waveform diagram:	50.00Hz	○
P08.33	FDT1 retention detection value		5.0%	○
P08.34	FDT2 electrical level detection value		50.00Hz	○
P08.35	FDT2 retention detection value	Setting range of P08.32: 0.00Hz – P00.03 (the max frequency) Setting range of P08.33 and P08.35: 0.0 – 100.0% Setting range of P08.34: 0.00Hz – P00.03 (the max frequency)	5.0%	○
P08.36	Frequency arrival detection value	When the output frequency is among the below or above range of the set frequency, the multi-function digital output terminal will output the signal of “frequency arrival”, see the diagram below for detailed information: 	0.00Hz	○
P08.37	Energy Braking enable	This parameter is used to control the internal braking unit. 0: Disabled 1: Enabled <b>Note:</b> Only applied to internal braking unit.	0	○
P08.38	Energy braking threshold voltage	After setting the original bus voltage to brake the energy, adjust the voltage appropriately to brake the load. The factory changes with the voltage level. The setting range: 200.0 – 2000.0V	220V voltage: 380.0V 380V voltage: 700.0V	○

Function code	Name	Detailed instruction of parameters	Default value	Modify						
		In order to prevent customers set the value is too large, it is recommended setting range: <table border="1" style="margin-left: 20px;"> <tr> <td>Voltage</td> <td>220V</td> <td>380V</td> </tr> <tr> <td>Range</td> <td>375 – 400V</td> <td>685 – 750V</td> </tr> </table>	Voltage	220V	380V	Range	375 – 400V	685 – 750V		
Voltage	220V	380V								
Range	375 – 400V	685 – 750V								
P08.39	Cooling fan running mode	0: Rated running mode 1: The fan keeps on running after power on	0	○						
P08.40	PWM selection	0x000 – 0x0021 LED ones: PWM mode selection 0: PWM mode 1, three-phase modulation and two-modulation 1: PWM mode 2, three-phase modulation LED tens: low-speed carrier frequency limit mode 0: Low-speed carrier frequency limit mode 1, the carrier frequency will limit to 1k or 2k if it exceeds 2k at low speed 1: Low-speed carrier frequency limit mode 2, the carrier frequency will limit to 4k if it exceeds 4k at low speed 2: No limit	0x01	◎						
P08.41	Over commission selection	LED ones 0: Invalid 1: Valid	0x00	◎						
		LED tens (for factory commissioning) 0: Light overcommission; in zone 1 1: Heavy overcommission; in zone 2 The default value of the inverters of 1PH 220V/3PH 380V (≤2.2kW) and 3PH 220V (≤0.75kW) is 00; The default value of the inverters of 3PH 380V (≥4kW) and 3PH 220V (≥1.5kW) is 01.	0x01							
P08.42	Keypad data control setting	0x0000 – 0x1223 LED ones: frequency enable selection 0: Both $\wedge/\vee$ keys and analog potentiometer adjustments are valid 1: Only $\wedge/\vee$ keys adjustment is valid 2: Only analog potentiometer adjustments is valid 3: Neither $\wedge/\vee$ keys nor digital potentiometer adjustments are valid LED tens: frequency control selection 0: Only valid when P00.06=0 or P00.07=0 1: Valid for all frequency setting manner 2: Invalid for multi-step speed when multi-step speed has the priority LED hundreds: action selection during stopping 0: Setting is valid 1: Valid during running, cleared after stopping 2: Valid during running, cleared after receiving the stop command LED thousands: $\wedge/\vee$ keys and analog potentiometer integral function	0x0000	○						

Function code	Name	Detailed instruction of parameters	Default value	Modify
		0: The Integral function is valid 1: The Integral function is invalid		
P08.43	Integral ratio of the keypad potentiometer	0.01 – 10.00s	0.10s	○
P08.44	UP/DOWN terminals control setting	0x00 – 0x221 LED ones: frequency control selection 0: UP/DOWN terminals setting valid 1: UP/DOWN terminals setting valid LED tens: frequency control selection 0: Only valid when P00.06=0 or P00.07=0 1: All frequency means are valid 2: When the multi-step are priority, it is invalid to the multi-step LED hundreds: action selection when stop 0: Setting valid 1: Valid in the running, clear after stop 2: Valid in the running, clear after receiving the stop commands	0x000	○
P08.45	UP terminals frequency changing ratio	0.01 – 50.00s	0.50 s	○
P08.46	DOWN terminals frequency changing ratio	0.01 – 50.00s	0.50 s	○
P08.47	Action selection at power loss	0x000 – 0x111 LED ones: Action selection when power off. 0: Save when power off 1: Clear when power off LED tens: Action selection when MODBUS set frequency off 0: Save when power off 1: Clear when power off LED hundreds: The action selection when other frequency set frequency off 0: Save when power off 1: Clear when power off	0x000	○
P08.48	High bit of original power consumption	This parameter is used to set the original value of the power consumption. The original value of the power consumption	0 kWh	○
P08.49	Low bit of original power consumption	=P08.48*1000+ P08.49 Setting range of P08.48: 0 – 59999 kWh (k) Setting range of P08.49: 0.0 – 999.9 kWh	0.0 kWh	○
P08.50	Magnetic flux braking coefficient	This function code is used to enable magnetic flux. 0: Invalid. 100 – 150: the bigger the coefficient, the bigger the braking strength. This inverter can slow down the motor by increasing the magnetic flux. The energy	0	○

Function code	Name	Detailed instruction of parameters	Default value	Modify
		<p>generated by the motor during braking can be transformed into heat energy by increasing the magnetic flux.</p> <p>The inverter monitors the state of the motor continuously even during the magnetic flux period. So the magnetic flux can be used in the motor stop, as well as to change the rotation speed of the motor. Its other advantages are:</p> <p>Brake immediately after the stop command. It does not need to wait the magnetic flux weaken. The cooling is better. The current of the stator other than the rotor increases during magnetic flux braking, while the cooling of the stator is more effective than the rotor.</p>		
P08.51	Input power factor of the inverter	This function code is used to adjust the displayed current of the AC input side. Setting range: 0.00 – 1.00	0.56	○
<b>P09 Group PID control</b>				
P09.00	PID reference source	<p>When the frequency command selection (P00.06, P00.07) is 7 or the voltage setting channel selection (P04.27) is 6, the running mode of the inverter is procedure PID controlled.</p> <p>The parameter determines the target given channel during the PID procures.</p> <p>0: Keypad digital given (P09.01) 1: Analog channel AI1 given 2: Analog channel AI2 given 3: Analog channel AI3 set 4: High speed pulse HDI set 5: Multi-step speed set 6: MODBUS communication set 7 – 9: Reserved</p> <p>The setting target of procedure PID is a relative one, 100% of the setting equals to 100% of the response of the controlled system.</p> <p>The system is calculated according to the relative value (0 – 100.0%).</p> <p><b>Note:</b> Multi-step speed given, it is realized by setting P10 group parameters.</p>	0	○
P09.01	Keypad PID preset	When P09.00=0, set the parameter whose basic value is the feedback value of the system. The setting range: -100.0% – 100.0%	0.0%	○
P09.02	PID feedback source	<p>Select the PID channel by the parameter.</p> <p>0: Analog channel AI1 feedback 1: Analog channel AI2 feedback 2: Analog channel AI3 feedback 3: High speed HDI feedback 4: MODBUS communication feedback 5 – 7: Reserved</p> <p><b>Note:</b> The reference channel and the feedback</p>	0	○

Function code	Name	Detailed instruction of parameters	Default value	Modify
		channel cannot coincide, otherwise, PID cannot control effectively.		
P09.03	PID output feature	0: PID output is positive: when the feedback signal exceeds the PID reference value, the output frequency of the inverter will decrease to balance the PID. For example, the strain PID control during wrap-up 1: PID output is negative: When the feedback signal is stronger than the PID reference value, the output frequency of the inverter will increase to balance the PID. For example, the strain PID control during wrap down	0	○
P09.04	Proportional gain (Kp)	The function is applied to the proportional gain P of PID input. P determines the strength of the whole PID adjuster. The parameter of 100 means that when the offset of PID feedback and given value is 100%, the adjusting range of PID adjuster is the max frequency (ignoring integral function and differential function). The setting range: 0.00 – 100.00	1.00	○
P09.05	Interval time (Ti)	This parameter determines the speed of PID adjuster to carry out integral adjustment on the deviation of PID feedback and reference. When the deviation of PID feedback and reference is 100%, the integral adjuster works continuously after the time (ignoring the proportional effect and differential effect) to achieve the max frequency (P00.03) or the max voltage (P04.31). Shorter the integral time, stronger is the adjustment Setting range: 0.00 – 10.00s	0.10s	○
P09.06	Differential time (Td)	This parameter determines the strength of the change ratio when PID adjuster carries out integral adjustment on the deviation of PID feedback and reference. If the PID feedback changes 100% during the time, the adjustment of integral adjuster (ignoring the proportional effect and differential effect) is the max frequency (P00.03) or the Max Voltage (P04.31). Longer the integral time, stronger is the adjusting. Setting range: 0.00 – 10.00s	0.00s	○
P09.07	Sampling cycle (T)	This parameter means the sampling cycle of the feedback. The modulator calculates in each sampling cycle. The longer the sampling cycle is, the slower the response is. Setting range: 0.001 – 10.000s	0.100s	○
P09.08	PID control deviation limit	The output of PID system is relative to the maximum deviation of the close loop reference. As shown in the diagram below, PID adjuster stops to work during the deviation limit. Set the function	0.0%	○

Function code	Name	Detailed instruction of parameters	Default value	Modify
		<p>properly to adjust the accuracy and stability of the system.</p> <p>Setting range: 0.0 – 100.0%</p>		
P09.09	Output upper limit of PID	These parameters are used to set the upper and lower limit of the PID adjustor output.	100.0%	○
P09.10	Output lower limit of PID	100.0 % corresponds to Max Frequency or the max voltage of ( P04.31) Setting range of P09.09: P09.10 – 100.0% Setting range of P09.10: -100.0% – P09.09	0.0%	○
P09.11	Feedback offline detection value	Set the PID feedback offline detection value, when the detection value is smaller than or equal to the feedback offline detection value, and the lasting time exceeds the set value in P09.12, the inverter will report "PID feedback offline fault" and the keypad will display PIDE.	0.0%	○
P09.12	Feedback offline detection time	<p>Setting range of P09.11: 0.0 – 100.0% Setting range of P09.12: 0.0 – 3600.0s</p>	1.0s	○
P09.13	PID adjustment selection	<p>0x00 – 0x11 LED ones:</p> <p>0: Keep on integral adjustment when the frequency achieves the upper and low limit; the integration shows the change between the reference and the feedback unless it reaches the internal integral limit. When the trend between the reference and the feedback changes, it needs more time to offset the impact of continuous working and the integration will change with the trend.</p> <p>1: Stop integral adjustment when the frequency reaches the upper and low limit. If the integration keeps stable, and the trend between the reference and the feedback changes, the integration will change with the trend quickly.</p> <p>LED tens:</p>	0x0001	○



Function code	Name	Detailed instruction of parameters	Default value	Modify	
		0: The same with the setting direction; if the output of PID adjustment is different from the current running direction, the internal will output 0 forcedly. 1: Opposite to the setting direction LED hundreds: 0: Limit to the maximum frequency 1: Limit to A frequency LED thousands: 0: A+B frequency, buffer ACC/DEC is invalid for the main reference A frequency source 1: A+B frequency, buffer ACC/DEC is valid for the main reference A frequency source and the ACC/DEC is determined by time 4 of P08.04			
P09.14	Proportional gain at low frequency (Kp)	0.00 – 100.00	1.00	○	
P09.15	PID command of ACC/DEC time	0.0 – 1000.0s	0.0s	○	
P09.16	PID output filter time	0.000 – 10.000s	0.000s	○	
<b>P10 Group Simple PLC and multi-step speed control</b>					
P10.00	Simple PLC means	0: Stop after running once. The inverter has to be commanded again after finishing a cycle. 1: Run at the final value after running once. After finish a signal, the inverter will keep the running frequency and direction of the last run. 2: Cycle running. The inverter will keep on running until receiving a stop command and then, the system will stop.	0	○	
P10.01	Simple PLC memory selection	0: Power loss without memory 1: Power loss memory: PLC record the running stage and frequency when power loss.	0	○	
P10.02	Multi-step speed 0	100.0% of the frequency setting corresponds to the max frequency P00.03.	0.0%	○	
P10.03	Running time of stage 0	When selecting simple PLC running, set P10.02 – P10.33 to define the running frequency and direction of all stages.	0.0s	○	
P10.04	Multi-step speed 1		0.0%	○	
P10.05	Running time of stage 1	<b>Note:</b> The symbol of multi-step determines the running direction of simple PLC. The negative value means reverse rotation.	0.0s	○	
P10.06	Multi-step speed 2		0.0%	○	
P10.07	Running time of stage 2		0.0s	○	
P10.08	Multi-step speed 3		0.0%	○	
P10.09	Running time of stage 3		multi-step speeds are in the range of $-f_{max} - f_{max}$	0.0s	○

Function code	Name	Detailed instruction of parameters	Default value	Modify																																														
P10.10	Multi-step speed 4	and it can be set continuously.	0.0%	○																																														
P10.11	Running time of stage 4	MSI20-EU series inverters can set 16 stages speed, selected by the combination of multi-step terminals 1 – 4, corresponding to the speed 0 to speed 15.	0.0s	○																																														
P10.12	Multi-step speed 5		0.0%	○																																														
P10.13	Running time of stage 5		0.0s	○																																														
P10.14	Multi-step speed 6		0.0%	○																																														
P10.15	Running time of stage 6		0.0s	○																																														
P10.16	Multi-step speed 7		0.0%	○																																														
P10.17	Running time of stage 7		0.0s	○																																														
P10.18	Multi-step speed 8		When S1=S2=S3=S4=OFF, the frequency input manner is selected via code P00.06 or P00.07.	0.0%	○																																													
P10.19	Running time of stage 8		When all S1=S2=S3=S4 terminals aren't off, it runs at multi-step which takes precedence of keypad, analog value, high-speed pulse, PLC, communication frequency input. Select at most 16 stages speed via the combination code of S1, S2, S3, and S4.	0.0s	○																																													
P10.20	Multi-step speed 9		The start-up and stopping of multi-step running is determined by function code P00.06, the relationship between S1, S2, S3, S4 terminals and multi-step speed is as following:	0.0%	○																																													
P10.21	Running time of stage 9			0.0s	○																																													
P10.22	Multi-step speed 10			0.0%	○																																													
P10.23	Running time of stage 10		<table border="1"> <tr><td>S1</td><td>OFF</td><td>ON</td><td>OFF</td><td>ON</td><td>OFF</td><td>ON</td><td>OFF</td><td>ON</td></tr> <tr><td>S2</td><td>OFF</td><td>OFF</td><td>ON</td><td>ON</td><td>OFF</td><td>OFF</td><td>ON</td><td>ON</td></tr> <tr><td>S3</td><td>OFF</td><td>OFF</td><td>OFF</td><td>OFF</td><td>ON</td><td>ON</td><td>ON</td><td>ON</td></tr> <tr><td>S4</td><td>OFF</td><td>OFF</td><td>OFF</td><td>OFF</td><td>OFF</td><td>OFF</td><td>OFF</td><td>OFF</td></tr> <tr><td>step</td><td>0</td><td>1</td><td>2</td><td>3</td><td>4</td><td>5</td><td>6</td><td>7</td></tr> </table>	S1	OFF	ON	OFF	ON	OFF	ON	OFF	ON	S2	OFF	OFF	ON	ON	OFF	OFF	ON	ON	S3	OFF	OFF	OFF	OFF	ON	ON	ON	ON	S4	OFF	OFF	OFF	OFF	OFF	OFF	OFF	OFF	step	0	1	2	3	4	5	6	7	0.0s	○
S1	OFF		ON	OFF	ON	OFF	ON	OFF	ON																																									
S2	OFF		OFF	ON	ON	OFF	OFF	ON	ON																																									
S3	OFF		OFF	OFF	OFF	ON	ON	ON	ON																																									
S4	OFF		OFF	OFF	OFF	OFF	OFF	OFF	OFF																																									
step	0	1	2	3	4	5	6	7																																										
P10.24	Multi-step speed 11	<table border="1"> <tr><td>S1</td><td>OFF</td><td>ON</td><td>OFF</td><td>ON</td><td>OFF</td><td>ON</td><td>OFF</td><td>ON</td></tr> <tr><td>S2</td><td>OFF</td><td>OFF</td><td>ON</td><td>ON</td><td>OFF</td><td>OFF</td><td>ON</td><td>ON</td></tr> <tr><td>S3</td><td>OFF</td><td>OFF</td><td>OFF</td><td>OFF</td><td>ON</td><td>ON</td><td>ON</td><td>ON</td></tr> <tr><td>S4</td><td>ON</td><td>ON</td><td>ON</td><td>ON</td><td>ON</td><td>ON</td><td>ON</td><td>ON</td></tr> <tr><td>step</td><td>8</td><td>9</td><td>10</td><td>11</td><td>12</td><td>13</td><td>14</td><td>15</td></tr> </table>	S1	OFF	ON	OFF	ON	OFF	ON	OFF	ON	S2	OFF	OFF	ON	ON	OFF	OFF	ON	ON	S3	OFF	OFF	OFF	OFF	ON	ON	ON	ON	S4	ON	ON	ON	ON	ON	ON	ON	ON	step	8	9	10	11	12	13	14	15	0.0%	○	
S1	OFF	ON	OFF	ON	OFF	ON	OFF	ON																																										
S2	OFF	OFF	ON	ON	OFF	OFF	ON	ON																																										
S3	OFF	OFF	OFF	OFF	ON	ON	ON	ON																																										
S4	ON	ON	ON	ON	ON	ON	ON	ON																																										
step	8	9	10	11	12	13	14	15																																										
P10.25	Running time of stage 11		0.0s	○																																														
P10.26	Multi-step speed 12		0.0%	○																																														
P10.27	Running time of stage 12	Setting range of P10.(2n, 1<n<17): -100.0 – 100.0%	0.0s	○																																														
P10.28	Multi-step speed 13	Setting range of P10.(2n+1, 1<n<17): 0.0 – 6553.5s (min)	0.0%	○																																														
P10.29	The running time of stage 13		0.0s	○																																														
P10.30	Multi-step speed 14		0.0%	○																																														
P10.31	Running time of stage 14		0.0s	○																																														
P10.32	Multi-step speed 15		0.0%	○																																														
P10.33	Running time of stage 15		0.0s	○																																														

Function code	Name	Detailed instruction of parameters	Default value	Modify																																																																																																									
P10.34	Simple PLC 0 – 7 stage ACC/DEC time selection	Below is the detailed instruction: <table border="1"> <thead> <tr> <th>Function code</th> <th>Binary bit</th> <th>Step</th> <th>ACC/DEC 0</th> <th>ACC/DEC 1</th> <th>ACC/DEC 2</th> <th>ACC/DEC 3</th> </tr> </thead> <tbody> <tr> <td rowspan="7">P10.34</td> <td>BIT1 BIT0</td> <td>0</td> <td>00</td> <td>01</td> <td>10</td> <td>11</td> </tr> <tr> <td>BIT3 BIT2</td> <td>1</td> <td>00</td> <td>01</td> <td>10</td> <td>11</td> </tr> <tr> <td>BIT5 BIT4</td> <td>2</td> <td>00</td> <td>01</td> <td>10</td> <td>11</td> </tr> <tr> <td>BIT7 BIT6</td> <td>3</td> <td>00</td> <td>01</td> <td>10</td> <td>11</td> </tr> <tr> <td>BIT9 BIT8</td> <td>4</td> <td>00</td> <td>01</td> <td>10</td> <td>11</td> </tr> <tr> <td>BIT11 BIT10</td> <td>5</td> <td>00</td> <td>01</td> <td>10</td> <td>11</td> </tr> <tr> <td>BIT13 BIT12</td> <td>6</td> <td>00</td> <td>01</td> <td>10</td> <td>11</td> </tr> <tr> <td>BIT15 BIT14</td> <td>7</td> <td>00</td> <td>01</td> <td>10</td> <td>11</td> </tr> <tr> <td rowspan="7">P10.35</td> <td>BIT1 BIT0</td> <td>8</td> <td>00</td> <td>01</td> <td>10</td> <td>11</td> </tr> <tr> <td>BIT3 BIT2</td> <td>9</td> <td>00</td> <td>01</td> <td>10</td> <td>11</td> </tr> <tr> <td>BIT5 BIT4</td> <td>10</td> <td>00</td> <td>01</td> <td>10</td> <td>11</td> </tr> <tr> <td>BIT7 BIT6</td> <td>11</td> <td>00</td> <td>01</td> <td>10</td> <td>11</td> </tr> <tr> <td>BIT9 BIT8</td> <td>12</td> <td>00</td> <td>01</td> <td>10</td> <td>11</td> </tr> <tr> <td>BIT11 BIT10</td> <td>13</td> <td>00</td> <td>01</td> <td>10</td> <td>11</td> </tr> <tr> <td>BIT13 BIT12</td> <td>14</td> <td>00</td> <td>01</td> <td>10</td> <td>11</td> </tr> <tr> <td>BIT15 BIT14</td> <td>15</td> <td>00</td> <td>01</td> <td>10</td> <td>11</td> </tr> </tbody> </table>	Function code	Binary bit	Step	ACC/DEC 0	ACC/DEC 1	ACC/DEC 2	ACC/DEC 3	P10.34	BIT1 BIT0	0	00	01	10	11	BIT3 BIT2	1	00	01	10	11	BIT5 BIT4	2	00	01	10	11	BIT7 BIT6	3	00	01	10	11	BIT9 BIT8	4	00	01	10	11	BIT11 BIT10	5	00	01	10	11	BIT13 BIT12	6	00	01	10	11	BIT15 BIT14	7	00	01	10	11	P10.35	BIT1 BIT0	8	00	01	10	11	BIT3 BIT2	9	00	01	10	11	BIT5 BIT4	10	00	01	10	11	BIT7 BIT6	11	00	01	10	11	BIT9 BIT8	12	00	01	10	11	BIT11 BIT10	13	00	01	10	11	BIT13 BIT12	14	00	01	10	11	BIT15 BIT14	15	00	01	10	11	0x0000	○
Function code	Binary bit	Step	ACC/DEC 0	ACC/DEC 1	ACC/DEC 2	ACC/DEC 3																																																																																																							
P10.34	BIT1 BIT0	0	00	01	10	11																																																																																																							
	BIT3 BIT2	1	00	01	10	11																																																																																																							
	BIT5 BIT4	2	00	01	10	11																																																																																																							
	BIT7 BIT6	3	00	01	10	11																																																																																																							
	BIT9 BIT8	4	00	01	10	11																																																																																																							
	BIT11 BIT10	5	00	01	10	11																																																																																																							
	BIT13 BIT12	6	00	01	10	11																																																																																																							
BIT15 BIT14	7	00	01	10	11																																																																																																								
P10.35	BIT1 BIT0	8	00	01	10	11																																																																																																							
	BIT3 BIT2	9	00	01	10	11																																																																																																							
	BIT5 BIT4	10	00	01	10	11																																																																																																							
	BIT7 BIT6	11	00	01	10	11																																																																																																							
	BIT9 BIT8	12	00	01	10	11																																																																																																							
	BIT11 BIT10	13	00	01	10	11																																																																																																							
	BIT13 BIT12	14	00	01	10	11																																																																																																							
BIT15 BIT14	15	00	01	10	11																																																																																																								
P10.35	Simple PLC 8 – 15 stage ACC/DEC time selection	After the users select the corresponding ACC/DEC time, the combining 16 binary bit will change into decimal bit, and then set the corresponding function codes. Setting range: -0x0000 – 0xFFFF	0x0000	○																																																																																																									
P10.36	PLC restart mode	0: Restart from the first stage; stop during running (cause by the stop command, fault or power loss), run from the first stage after restart. 1: Continue to run from the stop frequency; stop during running (cause by stop command and fault), the inverter will record the running time automatically, enter into the stage after restart and keep the remaining running at the setting frequency.	0	◎																																																																																																									
P10.37	Multi-step time unit selection	0: Seconds; the running time of all stages is counted by second 1: Minutes; the running time of all stages is counted by minute	0	◎																																																																																																									
<b>P11 Group Protective parameters</b>																																																																																																													
P11.00	Phase loss protection	0x00 – 0x11 LED ones: 0: Input phase loss software protection disable 1: Input phase loss software protection enable LED tens: 0: Output phase loss protection disable 1: Output phase loss protection enable LED hundreds: 0: Input phase loss hardware protection disable 1: Input phase loss hardware protection enable	0x10	○																																																																																																									

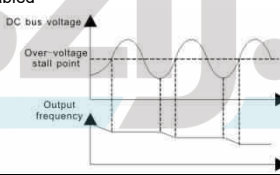
Function code	Name	Detailed instruction of parameters	Default value	Modify								
P11.01	Frequency-decreasing at sudden power loss	0: Enabled 1: Disabled	0	○								
P11.02	Frequency decreasing ratio at sudden power loss	<p>Setting range: 0.00Hz/s – P00.03 (the Max frequency)</p> <p>After the power loss of the grid, the bus voltage drops to the sudden frequency-decreasing point, the inverter begin to decrease the running frequency at P11.02, to make the inverter generate power again. The returning power can maintain the bus voltage to ensure a rated running of the inverter until the recovery of power.</p> <table border="1"> <tr> <td>Voltage degree</td> <td>220V</td> <td>380V</td> <td>660V</td> </tr> <tr> <td>Frequency-decreasing point at sudden power loss</td> <td>260V</td> <td>460V</td> <td>800V</td> </tr> </table> <p><b>Note:</b> 1. Adjust the parameter properly to avoid the stopping caused by inverter protection during the switching of the grid. 2. Prohibit the input phase loss protection to enable this function.</p>	Voltage degree	220V	380V	660V	Frequency-decreasing point at sudden power loss	260V	460V	800V	10.00 Hz/s	○
Voltage degree	220V	380V	660V									
Frequency-decreasing point at sudden power loss	260V	460V	800V									
P11.03	Overvoltage stall protection	<p>0: Disabled 1: Enabled</p> 	1	○								
P11.04	Overvoltage stall voltage protection	120 – 150% (standard bus voltage) (380V)	136%	○								
		120 – 150% (standard bus voltage) (220V)	120%									
P11.05	Current limit action	<p>The actual increasing ratio is less than the ratio of output frequency because of the big load during ACC running. It is necessary to take measures to avoid overcurrent fault and the inverter trips. During the running of the inverter, this function will detect the output current and compare it with the limit level defined in P11.06. If it exceeds the level, the inverter will run at stable frequency in ACC running, or the inverter will derate to run during the constant running. If it exceeds the level continuously, the output frequency will keep on decreasing to the lower limit. If the output current is detected to be lower than the limit level, the inverter will accelerate to run.</p>	0x01	⊙								
P11.06	Automatic current limit level		G: 160.0%	⊙								
P11.07	The decreasing ratio during current limit		10.00 Hz/s	⊙								

Function code	Name	Detailed instruction of parameters	Default value	Modify
		<p>Setting range of P11.05:            0: current limit invalid            1: current limit valid            2: current limit is invalid during constant speed            Setting range of P11.05: 0x00 – 0x12            Setting range of P11.06: 50.0 – 200.0%            Setting range of P11.07: 0.00 – 50.00Hz/s</p>		
P11.08	Overload pre-alarm of the motor/ inverter	<p>The output current of the inverter or the motor is above P11.09 and the lasting time is beyond P11.10, overload pre-alarm will be output.</p>	0x000	○
P11.09	Overload pre-alarm test level		150%	○
P11.10	Overload pre-alarm detection time	<p>Setting range of P11.08:            Enable and define the overload pre-alarm of the inverter or the motor.            Setting range: 0x000 – 0x131            LED ones:            0: Overload pre-alarm of the motor, comply with the rated current of the motor            1: Overload pre-alarm of the inverter, comply with the rated current of the inverter            LED tens:            0: The inverter continues to work after underload pre-alarm            1: The inverter continues to work after underload pre-alarm and the inverter stops to run after overload fault            2: The inverter continues to work after overload pre-alarm and the inverter stops to run after underload fault            3: The inverter stops when overloading or underloading.            LED hundreds :            0: Detection all the time            1: Detection in constant running            Setting range of P11.09: P11.11 – 200%            Setting range of P11.10: 0.1 – 3600.0s</p>	1.0s	○

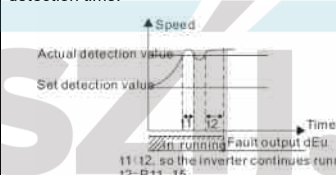
Function code	Name	Detailed instruction of parameters	Default value	Modify
P11.11	Detection level of underload pre-alarm	If the inverter current or the output current is lower than P11.11, and its lasting time is beyond P11.12, the inverter will output underload pre-alarm.	50%	○
P11.12	Detection time of underload pre-alarm	Setting range of P11.11: 0 – P11.09 Setting range of P11.12: 0.1 – 3600.0s	1.0s	○
P11.13	Output terminal action selection during fault	Select the action of fault output terminals on undervoltage and fault reset. 0x00 – 0x11 LED ones: 0: Action under fault undervoltage 1: No action under fault undervoltage LED tens: 0: Action during the automatic reset 1: No action during the automatic reset	0x00	○
P11.14	Speed deviation detection	0.0 – 50.0% Set the speed deviation detection time.	10.0%	○
P11.15	Speed deviation detection time	This parameter is used to set the speed deviation detection time.  Setting range of P11.15: 0.0 – 10.0s	0.5s	○
P11.16	Extension function selection	0x000 – 0x111 LED ones: Automatic frequency downgrade at voltage drop 0: Automatic frequency downgrade at voltage drop is invalid 1: Automatic frequency downgrade at voltage drop is valid LED tens: The second ACC/DEC time selection 0: The second ACC/DEC time detection selection is invalid 1: The second ACC/DEC time detection selection is valid; when the operation is above P08.36, ACC/DEC time is switched to the second ACC/DEC time LED hundreds: STO function selection 0: STO alarm locked Alarm lock means when STO appears, reset is a must after state recovery. 1: STO alarm unlocked STO alarm unlocked means when STO appears, STO alarm will disappeared automatically after state recovery.	0x000	○

Function code	Name	Detailed instruction of parameters	Default value	Modify
		Note: STL1 – STL3 are fault lock and cannot be reset		
<b>P13 Group Control parameters of SM</b>				
P13.13	Braking current of short circuit	After the inverter starts, when P01.00=0, set P13.14 to non-zero value and begin short circuit braking.	0.0%	○
P13.14	Braking retention time of start short circuit	After the inverter stops, when the operation frequency is less than P01.09, set P13.15 to non-zero value and begin stopping short-circuit braking and then DC braking.	0.00s	○
P13.15	Braking retention time of stop short circuit	Setting range of P13.13: 0.0 – 150.0% (inverters) Setting range of P13.14: 0.00 – 50.00s	0.00s	○
<b>P14 Group Serial communication</b>				
P14.00	local communication address	The setting range: 1 – 247 When the master is writing the frame, the communication address of the slave is set to 0; the broadcast address is the communication address. All slaves on the MODBUS fieldbus can receive the frame, but the slave doesn't answer. The communication address of the drive is unique in the communication net. This is the fundamental for the point to point communication between the upper monitor and the drive. <b>Note:</b> The address of the slave cannot set to 0.	1	○
P14.01	Communication baud ratio	Set the digital transmission speed between the upper monitor and the inverter. 0: 1200BPS 1: 2400BPS 2: 4800BPS 3: 9600BPS 4: 19200BPS 5: 38400BPS 6: 57600BPS <b>Note:</b> The baud rate between the upper monitor and the inverter must be the same. Otherwise, the communication is not applied. The bigger the baud rate, the quicker the communication speed.	4	○
P14.02	Digital bit checkout	The data format between the upper monitor and the inverter must be the same. Otherwise, the communication is not applied. 0: No check (N, 8, 1) for RTU 1: Even check (E, 8, 1) for RTU 2: Odd check (O, 8, 1) for RTU 3: No check (N, 8, 2) for RTU 4: Even check (E, 8, 2) for RTU 5: Odd check (O, 8, 2) for RTU 6: No check (N, 7, 1) for ASCII	1	○

Function code	Name	Detailed instruction of parameters	Default value	Modify
		7: Even check (E, 7, 1) for ASCII 8: Odd check (O, 7, 1) for ASCII 9: No check (N, 7, 2) for ASCII 10: Even check (E, 7, 2) for ASCII 11: Odd check (O, 7, 2) for ASCII 12: No check (N, 8, 1) for ASCII 13: Even check (E, 8, 1) for ASCII 14: Odd check (O, 8, 1) for ASCII 15: No check (N, 8, 2) for ASCII 16: Even check (E, 8, 2) for ASCII 17: Odd check (O, 8, 2) for ASCII		
P14.03	Communication answer delay	0 – 200ms It means the interval time between the interval time when the drive receive the data and sent it to the upper monitor. If the answer delay is shorter than the system processing time, then the answer delay time is the system processing time, if the answer delay is longer than the system processing time, then after the system deal with the data, waits until achieving the answer delay time to send the data to the upper monitor.	5	○
P14.04	Communication overtime fault time	0.0 (invalid), 0.1 – 60.0s When the function code is set as 0.0, the communication overtime parameter is invalid. When the function code is set as non-zero, if the interval time between two communications exceeds the communication overtime, the system will report "485 communication faults" (CE).	0.0s	○
P14.05	Transmission fault processing	0: Alarm and stop freely 1: No alarm and continue to run 2: No alarm and stop according to the stop means (only under the communication control) 3: No alarm and stop according to the stop means (under all control modes)	0	○
P14.06	Communication processing	0x00 – 0x11 LED ones: 0: Write with response: the inverter will respond to all reading and writing commands of the upper monitor. 1: Write without response: the inverter only responds to the reading command other than the writing command of the drive. The communication efficiency can be increased by this method. LED tens: (reserved) 0: Communication encrypting valid 1: Communication encrypting invalid	0x00	○
P14.07	Reserved			●
P14.08	Reserved			●
<b>P17 Group Monitoring function</b>				



Function code	Name	Detailed instruction of parameters	Default value	Modify
P17.00	Setting frequency	Display current set frequency of the inverter Range: 0.00Hz – P00.03		•
P17.01	Output frequency	Display current output frequency of the inverter Range: 0.00Hz – P00.03		•
P17.02	Ramp reference frequency	Display current ramp reference frequency of the inverter Range: 0.00Hz – P00.03		•
P17.03	Output voltage	Display current output voltage of the inverter Range: 0 – 1200V		•
P17.04	Output current	Display current output current of the inverter Range: 0.0 – 5000.0A		•
P17.05	Motor speed	Display the rotation speed of the motor. Range: 0 – 65535RPM		•
P17.06	Torque current	Display current torque current of the inverter Range: 0.0 – 5000.0A		•
P17.07	Magnetized current	Display current magnetized current of the inverter Range: 0.0 – 5000.0A		•
P17.08	Motor power	Display current power of the motor. Setting range: -300.0% – 300.0% (the rated current of the motor)		•
P17.09	Output torque	Display the current output torque of the inverter. Range: -250.0 – 250.0%		•
P17.10	The motor frequency evaluation	Evaluate the motor rotor frequency on open loop vector Range: 0.00 – P00.03		•
P17.11	DC bus voltage	Display current DC bus voltage of the inverter Range: 0.0 – 2000.0V		•
P17.12	Switch input terminals state	Display current Switch input terminals state of the inverter Range: 0000 – 00FF		•
P17.13	Switch output terminals state	Display current Switch output terminals state of the inverter Range: 0000 – 000F		•
P17.14	Digital adjustment	Display the adjustment through the keypad of the inverter. Range : 0.00Hz – P00.03		•
P17.15	Torque reference	Display the torque reference, the percentage to the current rated torque of the motor. Setting range: -300.0% – 300.0% (the rated current of the motor)		•
P17.16	Linear speed	Display the current linear speed of the inverter. Range: 0 – 65535		•
P17.17	Reserved			•
P17.18	Counting value	Display the current counting number of the inverter. Range: 0 – 65535		•
P17.19	AI1 input voltage	Display analog AI1 input signal Range: 0.00 – 10.00V		•
P17.20	AI2 input voltage	Display analog AI2 input signal Range: 0.00 – 10.00V		•

Function code	Name	Detailed instruction of parameters	Default value	Modify
P17.21	AI3 input voltage	Display analog AI2 input signal Range: -10.00 – 10.00V		•
P17.22	HDI input frequency	Display HDI input frequency Range: 0.00 – 50.00kHz		•
P17.23	PID reference value	Display PID reference value Range: -100.0 – 100.0%		•
P17.24	PID feedback value	Display PID feedback value Range: -100.0 – 100.0%		•
P17.25	Power factor of the motor	Display the current power factor of the motor. Range: -1.00 – 1.00		•
P17.26	Current running time	Display the current running time of the inverter. Range: 0 – 65535min		•
P17.27	Simple PLC and present stage of the multi-step speed	Display simple PLC and the current stage of the multi-step speed Range: 0 – 15		•
P17.28	ASR controller output	The percentage of the rated torque of the relative motor, display ASR controller output Range: -300.0% – 300.0% (rated motor current)		•
P17.29	Reserved			•
P17.30	Reserved			•
P17.31	Reserved			•
P17.32	Magnetic flux linkage	Display the magnetic flux linkage of the motor. Range: 0.0% – 200.0%		•
P17.33	Exciting current reference	Display the exciting current reference in the vector control mode. Range: -3000.0 – 3000.0A		•
P17.34	Torque current reference	Display the torque current reference in the vector control mode. Range: -3000.0 – 3000.0A		•
P17.35	AC input current	Display the input current in AC side. Range: 0.0 – 5000.0A		•
P17.36	Output torque	Display the output torque. Positive value is in the electromotion state, and negative value is in the power generating state. Range : -3000.0Nm – 3000.0Nm		•
P17.37	Motor overload counting	0 – 100 (OL1 when 100)		•
P17.38	PID output	Display PID output -100.00 – 100.00%		•
P17.39	Reserved			•

## 6 Fault Tracking

### 6.1 Maintenance intervals

If installed in an appropriate environment, the inverter requires very little maintenance. The table lists the routine maintenance intervals recommended by MORGENSEN.

Checking part	Checking item	Checking method	Criterion	
Ambient environment	Check the ambient temperature, humidity and vibration and ensure there is no dust, gas, oil fog and water drop.	Visual examination and instrument test	Conforming to the manual	
	Ensure there are no tools or other foreign or dangerous objects	Visual examination	There are no tools or dangerous objects.	
Voltage	Ensure the main circuit and control circuit are normal.	Measurement by millimeter	Conforming to the manual	
Keypad	Ensure the display is clear enough	Visual examination	The characters are displayed normally.	
	Ensure the characters are displayed totally	Visual examination	Conforming to the manual	
Main circuit	Ensure the screws are tightened scurrility	Tighten up	NA	
	Ensure there is no distortion, crackles, damage or color-changing caused by overheating and aging to the machine and insulator.	Visual examination	NA	
	Ensure there is no dust and dirtiness	Visual examination	NA <b>Note:</b> if the color of copper blocks change, it does not mean that there is something wrong with the features.	
	The lead of the conductors	Ensure that there is no distortion or color-changing of the conductors caused by overheating.	Visual examination	NA
		Ensure that there are no crackles or color-changing of the protective layers.	Visual examination	NA
	Terminals seat	Ensure that there is no damage	Visual examination	NA
	Filter capacitors	Ensure that there is no	Visual examination	NA

Checking part		Checking item	Checking method	Criterion
		weeping, color-changing, crackles and cassis expansion.		
		Ensure the safety valve is in the right place.	Estimate the usage time according to the maintenance or measure the static capacity.	NA
		If necessary, measure the static capacity.	Measure the capacity by instruments.	The static capacity is above or equal to the original value *0.85.
	Resistors	Ensure whether there is replacement and splitting caused by overheating.	Smelling and visual examination	NA
		Ensure that there is no offline.	Visual examination or remove one ending to coagulate or measure with multimeters	The resistors are in $\pm 10\%$ of the standard value.
	Transformers and reactors	Ensure there is no abnormal vibration, noise and smelling.	Hearing, smelling and visual examination	NA
	Electromagnetic contactor and relay	Ensure whether there is vibration noise in the workrooms.	Hearing	NA
		Ensure the contactor is good enough.	Visual examination	NA
Control circuit	PCB and plugs	Ensure there are no loose screws and contactors.	Fasten up	NA
		Ensure there is no smelling and color-changing.	Smelling and visual examination	NA
		Ensure there are no crackles, damage distortion and rust.	Visual examination	NA
		Ensure there is no weeping and distortion to the capacitors.	Visual examination or estimate the usage time according to the maintenance information	NA
Cooling system	Cooling fan	Estimate whether there is abnormal noise and vibration.	Hearing and Visual examination or rotate with hand	Stable rotation
		Estimate there is no losses screw.	Tighten up	NA

Checking part	Checking item	Checking method	Criterion
	Ensure there is no color-changing caused by overheating.	Visual examination or estimate the usage time according to the maintenance information	NA
Ventilating duct	Ensure whether there is stuff or foreign objection in the cooling fan, air vent.	Visual examination	NA

### 6.1.1 Cooling fan

The inverter's cooling fan has a minimum life span of 25,000 operating hours. The actual life span depends on the inverter usage and ambient temperature.

The operating hours can be found through P07.14 (accumulative hours of the inverter).

Fan failure can be predicted by the increasing noise from the fan bearings. If the inverter is operated in a critical part of a process, fan replacement is recommended once these symptoms appear. Replacement fans are available from MORGENSEN.



⚡ **Read and follow the instructions in chapter *Safety Precautions*. Ignoring the instructions would cause physical injury or death, or damage to the equipment.**

1. Stop the inverter and disconnect it from the AC power source and wait for at least the time designated on the inverter.
2. Lever the fan holder off the drive frame with a screwdriver and lift the hinged fan holder slightly upward from its front edge.
3. Disconnect the fan cable. Remove the installation bracket.
4. Install the bracket to the reversed direction. Pay attention the air direction of the inverter and the fan as the figure below:

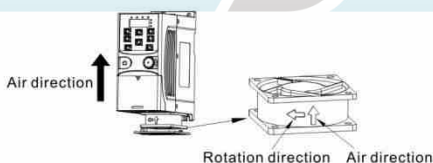

Fan installation of the inverters 1PH, 230V,  $\leq 2.2\text{kW}$

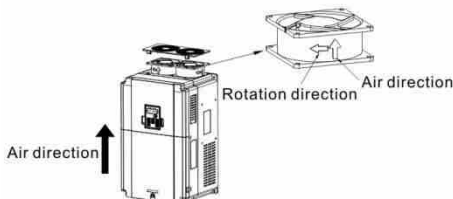

Fan installation of the inverters 3PH, 400V,  $\geq 4\text{kW}$

### 6.1.2 Capacitors

#### Reforming the capacitors

The DC bus capacitors must be reformed according to the operation instruction if the inverter has been stored for a long time. The storing time is counted from the producing date other than the delivery data which has been marked in the serial number of the inverter.

Time	Operational principle
Storing time less than 1 year	Operation without charging
Storing time 1-2 years	Connect with the power for 1 hour before first ON command.
Storing time 2-3 years	Use power surge to charge for the inverter <ul style="list-style-type: none"> <li>• Add 25% rated voltage for 30 minutes</li> <li>• Add 50% rated voltage for 30 minutes</li> <li>• Add 75% rated voltage for 30 minutes</li> <li>• Add 100% rated voltage for 30 minutes</li> </ul>
Storing time more than 3 years	Use power surge to charge for the inverter <ul style="list-style-type: none"> <li>• Add 25% rated voltage for 2 hours</li> <li>• Add 50% rated voltage for 2 hours</li> <li>• Add 75% rated voltage for 2 hours</li> <li>• Add 100% rated voltage for 2 hours</li> </ul>

The method of using power surge to charge for the inverter:

The right selection of power surge depends on the supply power of the inverter. Single phase 230V AC/2A power surge applied to the inverter with single/three-phase 230V AC as its input voltage. The inverter with single/three-phase 230V AC as its input voltage can apply Single phase 230V AC/2A power surge (L+ to R and N to S or T). All DC bus capacitors charge at the same time because there is one rectifier.

High-voltage inverter needs enough voltage (for example, 400V) during charging. The small capacitor (2A is enough) can be used because the capacitor nearly does not need current when charging.

#### Change electrolytic capacitors

	<p>⚡ <b>Read and follow the instructions in chapter <i>Safety Precautions</i>. Ignoring the instructions may cause physical injury or death, or damage to the equipment.</b></p>
-----------------------------------------------------------------------------------	----------------------------------------------------------------------------------------------------------------------------------------------------------------------------------

Change electrolytic capacitors if the working hours of electrolytic capacitors in the inverter are above 35000. Please contact with the local MORGENSEN offices or dial our national service hotline (400-700-9997) for detailed operation.

#### 6.1.3 Power cable

	<p>⚡ <b>Read and follow the instructions in chapter <i>Safety Precautions</i>. Ignoring the instructions may cause physical injury or death, or damage to the equipment.</b></p>
------------------------------------------------------------------------------------	----------------------------------------------------------------------------------------------------------------------------------------------------------------------------------

1. Stop the drive and disconnect it from the power line. Wait for at least the time designated on the inverter.
2. Check the tightness of the power cable connections.
3. Restore power.

#### 6.2 Fault solution

	<p>⚡ <b>Only qualified electricians are allowed to maintain the inverter. Read the safety instructions in chapter <i>Safety precautions</i> before working on the inverter.</b></p>
-------------------------------------------------------------------------------------	-------------------------------------------------------------------------------------------------------------------------------------------------------------------------------------

##### 6.2.1 Alarm and fault indications

Fault is indicated by LEDs. See **Operation Procedure**. When TRIP light is on, an alarm or fault message on the panel display indicates abnormal inverter state. Using the information given in this chapter, most alarm and fault cause can be identified and corrected. If not, contact with the MORGENSEN office.

##### 6.2.2 How to reset

The inverter can be reset by pressing the keypad key **STOP/RST**, through digital input, or by switching the power light. When the fault has been removed, the motor can be restarted.

### 6.2.3 Fault instruction and solution

Do as the following after the inverter fault:

1. Check to ensure there is nothing wrong with the keypad. If not, please contact with the local MORGENSEN office.
2. If there is nothing wrong, please check P07 and ensure the corresponding recorded fault parameters to confirm the real state when the current fault occurs by all parameters.
3. See the following table for detailed solution and check the corresponding abnormal state.
4. Eliminate the fault and ask for relative help.
5. Check to eliminate the fault and carry out fault reset to run the inverter.

Fault code	Fault type	Possible cause	Solutions
OUt1	IGBT Ph-U fault	<ul style="list-style-type: none"> <li>● The acceleration is too fast</li> </ul>	<ul style="list-style-type: none"> <li>● Increase Acc time</li> <li>● Change the power unit</li> <li>● Check the driving wires</li> <li>● Inspect external equipment and eliminate interference</li> </ul>
OUt2	IGBT Ph-V fault	<ul style="list-style-type: none"> <li>● IGBT module fault</li> <li>● Misaction caused by interference</li> </ul>	
OUt3	IGBT Ph-W fault	<ul style="list-style-type: none"> <li>● The connection of the driving wires is not good,</li> <li>● Grounding is not properly</li> </ul>	
OC1	Over-current when acceleration	<ol style="list-style-type: none"> <li>1. The acceleration or deceleration is too fast.</li> <li>2. The voltage of the grid is too low.</li> </ol>	<ol style="list-style-type: none"> <li>1. Increase the ACC time</li> <li>2. Check the input power</li> <li>3. Select the inverter with a larger power</li> <li>4. Check if the load is short circuited (the grounding short circuited or the wire short circuited) or the rotation is not smooth.</li> <li>5. Check the output configuration.</li> <li>6. Check if there is strong interference.</li> <li>7. Check the setting of relative function codes.</li> </ol>
OC2	Over-current when deceleration	<ol style="list-style-type: none"> <li>3. The power of the inverter is too low.</li> <li>4. The load transients or is abnormal.</li> <li>5. The grounding is short circuited or the output is phase loss.</li> </ol>	
OC3	Over-current when constant speed running	<ol style="list-style-type: none"> <li>6. There is strong external interference.</li> <li>7. The overvoltage stall protection is not open.</li> </ol>	
OV1	Over-voltage when acceleration	<ol style="list-style-type: none"> <li>1. The input voltage is abnormal.</li> <li>2. There is large energy feedback.</li> <li>3. No braking components.</li> <li>4. Braking energy is not open</li> </ol>	<ol style="list-style-type: none"> <li>1. Check the input power</li> <li>2. Check if the DEC time of the load is too short or the inverter starts during the rotation of the motor or it needs to increase the energy consumption components.</li> <li>3. Install the braking components.</li> <li>4. Check the setting of relative function codes.</li> </ol>
OV2	Over-voltage when deceleration		
OV3	Over-voltage when constant speed running		
UV	DC bus Under-voltage	<ol style="list-style-type: none"> <li>1. The voltage of the power supply is too low.</li> <li>2. The overvoltage stall protection is not open.</li> </ol>	<ol style="list-style-type: none"> <li>1. Check the input power of the supply line.</li> <li>2. Check the setting of relative function codes.</li> </ol>

<b>Fault code</b>	<b>Fault type</b>	<b>Possible cause</b>	<b>Solutions</b>
OL1	Motor overload	<ol style="list-style-type: none"> <li>1. The voltage of the power supply is too low.</li> <li>2. The motor setting rated current is incorrect.</li> <li>3. The motor stall or load transients is too strong.</li> </ol>	<ol style="list-style-type: none"> <li>1. Check the power of the supply line</li> <li>2. Reset the rated current of the motor</li> <li>3. Check the load and adjust the torque lift</li> </ol>
OL2	Inverter overload	<ol style="list-style-type: none"> <li>1. The acceleration is too fast</li> <li>2. Reset the rotating motor</li> <li>3. The voltage of the power supply is too low.</li> <li>4. The load is too heavy.</li> <li>5. Close loop vector control, reverse direction of the code panel and long low-speed operation</li> </ol>	<ol style="list-style-type: none"> <li>1. Increase the ACC time</li> <li>2. Avoid the restarting after stopping.</li> <li>3. Check the power of the supply line</li> <li>4. Select an inverter with bigger power.</li> <li>5. Select a proper motor.</li> </ol>
OL3	Electrical overload	The inverter will report overload pre-alarm according to the set value.	Check the load and the overload pre-alarm point.
SPI	Input phase loss	Phase loss or fluctuation of input R, S, T	<ol style="list-style-type: none"> <li>1. Check input power</li> <li>2. Check installation distribution</li> </ol>
SPO	Output phase loss	U, V, W phase loss input (or serious asymmetrical three phase of the load)	<ol style="list-style-type: none"> <li>1. Check the output distribution</li> <li>2. Check the motor and cable</li> </ol>
OH1	Rectify overheat	<ol style="list-style-type: none"> <li>1. Air duct jam or fan damage</li> <li>2. Ambient temperature is too high.</li> <li>3. The time of overload running is too long.</li> </ol>	<ol style="list-style-type: none"> <li>1. Refer to the overcurrent solution</li> <li>2. Redistribute dredge the wind channel or change the fan</li> <li>3. Low the ambient temperature</li> <li>4. Check and reconnect</li> <li>5. Change the power</li> <li>6. Change the power unit</li> <li>7. Change the main control panel</li> </ol>
OH2	IGBT overheat		
EF	External fault	SI external fault input terminals action	Check the external device input
CE	Communication error	<ol style="list-style-type: none"> <li>1. The baud rate setting is incorrect.</li> <li>2. Fault occurs to the communication wiring.</li> <li>3. The communication address is wrong.</li> <li>4. There is strong interference to the communication.</li> </ol>	<ol style="list-style-type: none"> <li>1. Set proper baud rate</li> <li>2. Check the communication connection distribution</li> <li>3. Set proper communication address.</li> <li>4. Chang or replace the connection distribution or improve the anti-interference capability.</li> </ol>



Fault code	Fault type	Possible cause	Solutions
ItE	Current detection fault	<ol style="list-style-type: none"> <li>1. The connection of the control board is not good</li> <li>2. Assistant power is bad</li> <li>3. Hall components is broken</li> <li>4. The modifying circuit is abnormal.</li> </ol>	<ol style="list-style-type: none"> <li>1. Check the connector and plug wire again</li> <li>2. Change the Hall</li> <li>3. Change the main control panel</li> </ol>
tE	Autotuning fault	<ol style="list-style-type: none"> <li>1. The motor capacity does not comply with the inverter capability</li> <li>2. The rated parameter of the motor does not set correctly.</li> <li>3. The offset between the parameters from autotune and the standard parameter is huge</li> <li>4. Autotune overtime</li> </ol>	<ol style="list-style-type: none"> <li>1. Change the inverter mode</li> <li>2. Set the rated parameter according to the motor name plate</li> <li>3. Empty the motor load.</li> <li>4. Check the motor connection and set the parameter.</li> <li>5. Check if the upper limit frequency is above 2/3 of the rated frequency.</li> </ol>
EEP	EEPROM fault	<ol style="list-style-type: none"> <li>1. Error of controlling the write and read of the parameters</li> <li>2. Damage to EEPROM</li> </ol>	<ol style="list-style-type: none"> <li>1. Press STOP/RST to reset</li> <li>2. Change the main control panel</li> </ol>
PIDE	PID feedback fault	<ol style="list-style-type: none"> <li>1. PID feedback offline</li> <li>2. PID feedback source disappear</li> </ol>	<ol style="list-style-type: none"> <li>1. Check the PID feedback signal</li> <li>2. Check the PID feedback source</li> </ol>
bCE	Braking unit fault	<ol style="list-style-type: none"> <li>1. Braking circuit fault or damage to the braking pipes</li> <li>2. The external braking resistor is not sufficient</li> </ol>	<ol style="list-style-type: none"> <li>1. Check the braking unit and , change new braking pipe</li> <li>2. Increase the braking resistor</li> </ol>
END	Time reach of factory setting	The actual running time of the inverter is above the internal setting running time.	Ask for the supplier and adjust the setting running time.
PCE	Keypad communication error	<p>The keypad is not in good connection or offline;</p> <p>The keypad cable is too long and there is strong interference;</p> <p>Part of the communication circuits of the keypad or main board have fault.</p>	<p>Check the keypad cable and ensure it is normal;</p> <p>Check the environment and eliminate the interference source;</p> <p>Change hardware and ask for maintenance service.</p>
UPE	Parameter upload error	<p>The keypad is not in good connection or offline;</p> <p>The keypad cable is too long and there is strong interference;</p> <p>Part of the communication circuits of the keypad or main board have fault.</p>	<p>Check the environment and eliminate the interference source;</p> <p>Change hardware and ask for maintenance service;</p> <p>Change hardware and ask for maintenance service.</p>

Fault code	Fault type	Possible cause	Solutions
DNE	Parameter download error	The keypad is not in good connection or offline; The keypad cable is too long and there is strong interference; Data storage error in keypad	Check the environment and eliminate the interference source; Change hardware and ask for maintenance service; Backup data in the keypad again
ETH1	Grounding shortcut fault 1	1.The output of the inverter is short circuited with the ground 2.There is fault in the current detection circuit 3.There is a great difference between the actual motor power setting and the inverter power	1.Check if the connection of the motor is normal or not 2.Change the hall 3.Change the main control panel 4.Reset motor parameters and ensure those parameters are correct
ETH2	Grounding shortcut fault 2		
LL	Electronic underload fault	The inverter will report the underload pre-alarm according to the set value.	Check the load and the underload pre-alarm point.
STO	Safe torque off	STO function operates normally	
STL1	Channel H1 abnormal	Fault or internal hardware circuit fault occurred to H1 channel	Replace STO switch; if problem persists after replacement, contact the manufacturer.
STL2	Channel H2 abnormal	Fault or internal hardware circuit fault occurred to H2 channel	
STL3	Channel H1 and H2 abnormal simultaneously	Fault or internal hardware circuit fault occurred to H1 and H2 channels simultaneously	
CrCE	Safe code FLASH CRC check fault	Error occurred to STO safe code FLASH CRC check	Contact the manufacturer.

### STO alarm

- When the hundreds of P11.16 is set to 0, the STO alarm is locked.

As shown in below fig 1, When H1 and H2 are 'OFF' during operation (safety function is required), the drive enters safety mode and stops output. STO alarm will only be disappeared once reset action is valid. External running command need to be reset for the drive to execute running command again.

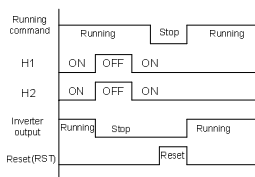

Fig 1

- When the hundreds of P11.16 is set to 1, the STO alarm will not be locked

As shown in below fig 2, alarm non-lock means when STO appears, the STO alarm will disappear automatically after state restoration, which requires no reset action. After reset of external running command, the drive will execute running command again.

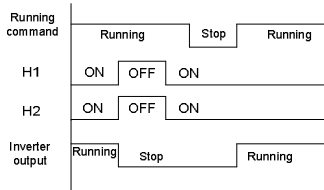

Fig 2

**STL1 fault**

As shown in below fig 3, when the hardware circuit of safety circuit 1 is abnormal while that of H2 signal is normal, namely, when H1 is abnormal during operation (safety function is required), the drive enters safety mode and stops output no matter whatever the running command is. Despite of reset commands and external running command reset, the drive will not execute running command again, and it is STL1 alarm lock all the time.

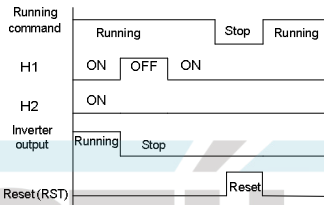

Fig 3

**STL 2 fault**

As shown in below fig 4, when the hardware circuit of safety circuit 2 is abnormal while that of H1 signal is normal, namely, when H2 is abnormal during operation (safety function is required), the drive enters safety mode and stops output no matter whatever the running command is. Despite of reset commands and external running command reset, the drive will not execute running command again, and it is STL2 alarm lock all the time.

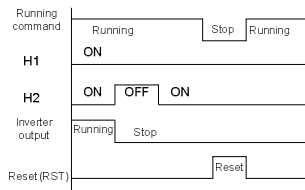

Fig 4

**6.2.4 Other states**

Fault code	Fault type	Possible cause	Solutions
PoFF	System power off	System power off or low DC voltage	Check the grid

## 7 Communication Protocol

### 7.1 Brief instruction to Modbus protocol

Modbus protocol is a software protocol and common language which is applied in the electrical controller. With this protocol, the controller can communicate with other devices via network (the channel of signal transmission or the physical layer, such as RS485). And with this industrial standard, the controlling devices of different manufacturers can be connected to an industrial network for the convenient of being monitored.

There are two transmission modes for Modbus protocol: ASCII mode and RTU (Remote Terminal Units) mode. On one Modbus network, all devices should select same transmission mode and their basic parameters, such as baud rate, digital bit, check bit, and stopping bit should have no difference.

Modbus network is a controlling network with single-master and multiple slaves, which means that there is only one device performs as the master and the others are the slaves on one Modbus network. The master means the device which has active talking right to send message to Modbus network for the controlling and inquiring to other devices. The slave means the passive device which sends data message to the Modbus network only after receiving the controlling or inquiring message (command) from the master (response). After the master sends message, there is a period of time left for the controlled or inquired slaves to response, which ensure there is only one slave sends message to the master at a time for the avoidance of singles impact.

Generally, the user can set PC, PLC, IPC and HMI as the masters to realize central control. Setting certain device as the master is a promise other than setting by a bottom or a switch or the device has a special message format. For example, when the upper monitor is running, if the operator clicks sending command bottom, the upper monitor can send command message actively even it cannot receive the message from other devices. In this case, the upper monitor is the master. And if the designer makes the inverter send the data only after receiving the command, then the inverter is the slave.

The master can communicate with any single slave or with all slaves. For the single-visiting command, the slave should feedback a response message; for the broadcasting message from the master, the slave does not need to feedback the response message.

### 7.2 Application of the inverter

The Modbus protocol of the inverter is RTU mode and the physical layer is 2-wire RS485.

#### 7.2.1 Two-wire RS485

The interface of 2-wire RS485 works on semiduplex and its data signal applies differential transmission which is called balance transmission, too. It uses twisted pairs, one of which is defined as A (+) and the other is defined as B (-). Generally, if the positive electrical level between sending drive A and B is among +2 – +6V, it is logic“1”, if the electrical level is among -2V – -6V; it is logic“0”.

485+ on the terminal board corresponds to A and 485- to B.

Communication baud rate means the binary bit number in one second. The unit is bit/s (bps). The higher the baud rate is, the quicker the transmission speed is and the weaker the anti-interference is. If the twisted pairs of 0.56mm (24AWG) is applied as the communication cables, the Max Transmission distance is as below:

Baud rate	Max transmission distance	Baud rate	Max transmission distance	Baud rate	Max transmission distance	Baud rate	Max transmission distance
2400 BPS	1800m	4800 BPS	1200m	9600 BPS	800m	19200 BPS	600m

It is recommended to use shield cables and make the shield layer as the grounding wires during RS485 remote communication.

In the cases with less devices and shorter distance, it is recommended to use 120Ω terminal resistor as the performance will be weakened if the distance increase even though the network can perform well without

load resistor.

### 7.2.1.1 Single application

Figure 1 is the site Modbus connection figure of single inverter and PC. Generally, the computer does not have RS485 interface, the RS232 or USB interface of the computer should be converted into RS485 by converter. Connect the A terminal of RS485 to the 485+ terminal of the inverter and B to the 485- terminal. It is recommended to use the shield twisted pairs. When applying RS232-RS485 converter, if the RS232 interface of the computer is connected to the RS232 interface of the converter, the wire length should be as short as possible within the length of 15m. It is recommended to connect the RS232-RS485 converter to the computer directly. If using USB-RS485 converter, the wire should be as short as possible, too.

Select a right interface to the upper monitor of the computer (select the interface of RS232-RS485 converter, such as COM1) after the wiring and set the basic parameters such as communication baud rate and digital check bit to the same as the inverter.

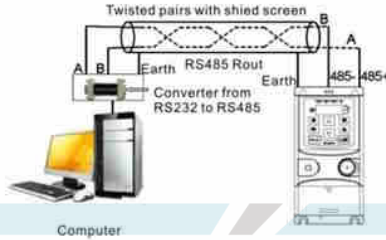

Figure 1 RS485 physical connection in single application

### 7.2.1.2 Multi-applications

In real multi-applications, the chrysanthemum connection and star connection are commonly used.

Chrysanthemum chain connection is required in the RS485 industrial fieldbus standards. The two ends are connected to terminal resistors of 120Ω which is shown as figure 2.

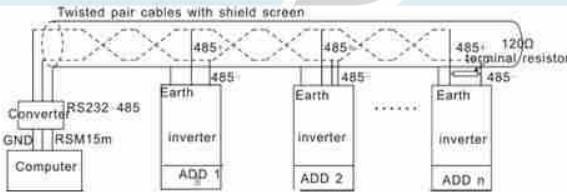

Figure 2 Chrysanthemum connection applications

Figure 3 is the star connection. Terminal resistor should be connected to the two devices which have the longest distance. (1# and 15#device)

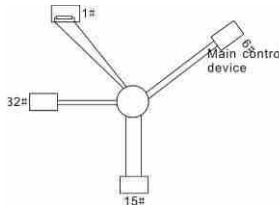

Figure 3 star connection

It is recommended to use shield cables in multiple connection. The basic parameter of the devices, such as baud rate and digital check bit in RS485 should be the same and there should be no repeated address.

## 7.2.2 RTU mode

### 7.2.2.1 RTU communication frame format

If the controller is set to communicate by RTU mode in Modbus network every 8bit byte in the message includes two 4Bit hex characters. Compared with ACSII mode, this mode can send more data at the same baud rate.

#### Code system

- 1 start bit
- 7 or 8 digital bit, the minimum valid bit can be sent firstly. Every 8 bit frame includes two hex characters (0...9, A...F)
- 1 even/odd check bit. If there is no checkout, the even/odd check bit is inexistent.
- 1 end bit (with checkout), 2 Bit (no checkout)

#### Error detection field

- CRC

The data format is illustrated as below:

11-bit character frame (BIT1 – BIT8 are the digital bits)

Start bit	BIT1	BIT2	BIT3	BIT4	BIT5	BIT6	BIT7	BIT8	Check bit	End bit
-----------	------	------	------	------	------	------	------	------	-----------	---------

10-bit character frame (BIT1 – BIT7 are the digital bits)

Start bit	BIT1	BIT2	BIT3	BIT4	BIT5	BIT6	BIT7	Check bit	End bit
-----------	------	------	------	------	------	------	------	-----------	---------

In one character frame, the digital bit takes effect. The start bit, check bit and end bit is used to send the digital bit right to the other device. The digital bit, even/odd checkout and end bit should be set as the same in real application.

The Modbus minimum idle time between frames should be no less than 3.5 bytes. The network device is detecting, even during the interval time, the network bus. When the first field (the address field) is received, the corresponding device decodes next transmitting character. When the interval time is at least 3.5 byte, the message ends.

The whole message frame in RTU mode is a continuous transmitting flow. If there is an interval time (more than 1.5 bytes) before the completion of the frame, the receiving device will renew the uncompleted message and suppose the next byte as the address field of the new message. As such, if the new message follows the previous one within the interval time of 3.5 bytes, the receiving device will deal with it as the same with the previous message. If these two phenomena all happen during the transmission, the CRC will generate a fault message to respond to the sending devices.

The standard structure of RTU frame:

START	T1-T2-T3-T4 (transmission time of 3.5 bytes)
ADDR	Communication address: 0 – 247 (decimal system) (0 is the broadcast address)
CMD	03H: read slave parameters 06H: write slave parameters
DATA (N-1) ... DATA (0)	The data of 2*N bytes are the main content of the communication as well as the core of data exchanging
CRC CHK low bit	Detection value: CRC (16BIT)
CRC CHK high bit	

END	T1-T2-T3-T4 (transmission time of 3.5 bytes)
-----	----------------------------------------------

### 7.2.2.2 RTU communication frame error checkout

Various factors (such as electromagnetic interference) may cause error in the data transmission. For example, if the sending message is a logic "1", A-B potential difference on RS485 should be 6V, but in reality, it may be -6V because of electromagnetic interference, and then the other devices take the sent message as logic "0". If there is no error checkout, the receiving devices will not find the message is wrong and they may give incorrect response which cause serious result. So the checkout is essential to the message.

The theme of checkout is that: the sender calculate the sending data according to a fixed formula, and then send the result with the message. When the receiver gets this message, they will calculate another result according to the same method and compare it with the sending one. If two results are the same, the message is correct. If not, the message is incorrect.

The error checkout of the frame can be divided into two parts: the bit checkout of the byte and the whole data checkout of the frame (CRC check).

#### Bit checkout of the byte

The user can select different bit checkouts or non-checkout, which impacts the check bit setting of each byte.

The definition of even checkout: add an even check bit before the data transmission to illustrate the number of "1" in the data transmission is odd number or even number. When it is even, the check byte is "0", otherwise, the check byte is "1". This method is used to stabilize the parity of the data.

The definition of odd checkout: add an odd check bit before the data transmission to illustrate the number of "1" in the data transmission is odd number or even number. When it is odd, the check byte is "0", otherwise, the check byte is "1". This method is used to stabilize the parity of the data.

For example, when transmitting "11001110", there are five "1" in the data. If the even checkout is applied, the even check bit is "1"; if the odd checkout is applied; the odd check bit is "0". The even and odd check bit is calculated on the check bit position of the frame. And the receiving devices also carry out even and odd checkout. If the parity of the receiving data is different from the setting value, there is an error in the communication.

#### CRC check

The checkout uses RTU frame format. The frame includes the frame error detection field which is based on the CRC calculation method. The CRC field is two bytes, including 16 figure binary values. It is added into the frame after calculated by transmitting device. The receiving device recalculates the CRC of the received frame and compares them with the value in the received CRC field. If the two CRC values are different, there is an error in the communication.

During CRC, 0xFFFF will be stored. And then, deal with the continuous 6-above bytes in the frame and the value in the register. Only the 8Bit data in every character is effective to CRC, while the start bit, the end and the odd and even check bit is ineffective.

The calculation of CRC applies the international standard CRC checkout principles. When the user is editing CRC calculation, he can refer to the relative standard CRC calculation to write the required CRC calculation program.

Here provided a simple function of CRC calculation for the reference (programmed with C language):

```
unsigned int crc_cal_value(unsigned char *data_value, unsigned char data_length)
{
    int i;
    unsigned int crc_value=0xffff;
    while(data_length--)
```

```

{  crc_value^=*data_value++;
    for(i=0;i<8;i++)
    {
if(crc_value&0x0001)crc_value=(crc_value>>1)^0xa001;
        else crc_value=crc_value>>1;
    }  }
return(crc_value);
}

```

In ladder logic, CKSM calculated the CRC value according to the frame with the table inquiry. The method is advanced with easy program and quick calculation speed. But the ROM space the program occupied is huge. So use it with caution according to the program required space.

### 7.2.3 ASCII mode

Name	Definition										
Coding system	Communication protocol belongs to hexadecimal system. The meaning of message character in ASCII: "0"... "9", "A"... "F", each hex is represented by the ASCII message corresponds to the character.										
	Character	'0'	'1'	'2'	'3'	'4'	'5'	'6'	'7'		
	ASCII CODE	0x30	0x31	0x32	0x33	0x34	0x35	0x36	0x37		
	Character	'8'	'9'	'A'	'B'	'C'	'D'	'E'	'F'		
	ASCII CODE	0x38	0x39	0x41	0x42	0x43	0x44	0x45	0x46		
Data format	Starting bit, 7/8 data bit, check bit and stop bit. The data formats are listed as below: 11-bit character frame:										
	Starting bit	BIT1	BIT2	BIT3	BIT4	BIT5	BIT6	BIT7	BIT8	Check bit	Stop bit
	10-bit character frame:										
	Starting bit	BIT1	BIT2	BIT3	BIT4	BIT5	BIT6	BIT7	Check bit	Stop bit	

In ASCII mode, the frame header is ":" ("0\*3A"), frame end is "CRLF" ("0\*0D" "0\*0A") by default. In ASCII mode, all the data bytes, except for the frame header and frame end, are transmitted in ASCII code mode, in which four high bit groups will be sent out first and then, four low bit groups will be sent out. In ASCII mode, the data length is 8 bit. As for 'A' – 'F', its capital letters is adopted for ASCII code. The data now adopts LRC checkout which covers slave address to data information. The checksum equals to the complement of the character sum of all the participated checkout data.

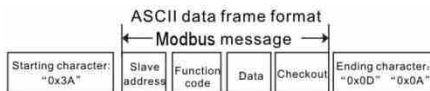

Standard structure of ASCII frame:

START	':' (0x3A)
Address Hi	Communication address: 8-bit address is formed by the combination of two ASCII codes
Address Lo	
Function Hi	Function code: 8-bit address is formed by the combination of two ASCII codes
Function Lo	
DATA (N-1)	Data content:
...	nx8-bit data content is formed by combination of 2n (n≤16)
DATA (0)	ASCII codes



LRC CHK Hi	LRC check code: 8-bit check code is formed by the combination of two ASCII codes.
LRC CHK Lo	
END Hi	End character: END Hi=CR (0x0D), END Lo=LF (0x0A)
END Lo	

### 7.2.3.1 ASCII mode check (LRC Check)

Check code (LRC Check) is the value combined of address and data content result. For instance, the check code of above 2.2.2 communication message is: 0x02+0x06+0x00+0x08+0x13+0x88=0xAB, then take the compliment of 2=0x55. Below is a simple LRC calculation function for user reference (programed with C language):

```

Static unsigned char
LRC(auchMsg,usDataLen)
unsigned char *auchMsg;
unsigned short usDataLen;
{
    unsigned char uchLRC=0;
    while(usDataLen--)
        uchLRC+=*auchMsg++;
    return((unsigned char)( - ((char)uchLRC)));
}

```

## 7.3 Command code and communication data illustration

### 7.3.1 RTU mode

#### 7.3.1.1 Command code: 03H

**03H (correspond to binary 0000 0011) ,read N words (Word) (the Max continuous reading is 16 words)**

Command code 03H means that if the master read data from the inverter, the reading number depends on the "data number" in the command code. The max continuous reading number is 16 and the parameter address should be continuous. The byte length of every data is 2 (one word). The following command format is illustrated by hex (a number with "H" means hex) and one hex occupies one byte.

The command code is used to read the working stage of the inverter.

For example, read continuous 2 data content from 0004H from the inverter with the address of 01H (read the content of data address of 0004H and 0005H), the frame structure is as below:

RTU master command message (from the master to the inverter)

START	T1-T2-T3-T4
ADDR	01H
CMD	03H
High bit of the start address	00H
Low bit of the start address	04H
High bit of data number	00H
Low bit of data number	02H
CRC low bit	85H
CRC high bit	CAH
END	T1-T2-T3-T4

T1-T2-T3-T4 between START and END is to provide at least the time of 3.5 bytes as the leisure time and distinguish two messages for the avoidance of taking two messages as one message.

**ADDR** = 01H means the command message is sent to the inverter with the address of 01H and ADDR occupies one byte

**CMD**=03H means the command message is sent to read data from the inverter and CMD occupies one

byte

“**Start address**” means reading data from the address and it occupies 2 bytes with the fact that the high bit is in the front and the low bit is in the behind.

“**Data number**” means the reading data number with the unit of word. If the “start address” is 0004H and the “data number” is 0002H, the data of 0004H and 0005H will be read.

**CRC** occupies 2 bytes with the fact that the high bit is in the front and the low bit is in the behind.

**RTU** slave response message (from the inverter to the master)

START	T1-T2-T3-T4
ADDR	01H
CMD	03H
Byte number	04H
Data high bit of address 0004H	13H
Data low bit of address 0004H	88H
Data high bit of address 0005H	00H
Data low bit of address 0005H	00H
CRC CHK low bit	7EH
CRC CHK high bit	9DH
END	T1-T2-T3-T4

The meaning of the response is that:

**ADDR** = 01H means the command message is sent to the inverter with the address of 01H and ADDR occupies one byte

**CMD**=03H means the message is received from the inverter to the master for the response of reading command and CMD occupies one byte

“**Byte number**” means all byte number from the byte (excluding the byte) to CRC byte (excluding the byte). 04 means there are 4 byte of data from the “byte number” to “CRC CHK low bit”, which are “digital address 0004H high bit”, “digital address 0004H low bit”, “digital address 0005H high bit” and “digital address 0005H low bit”.

There are 2 bytes stored in one data with the fact that the high bit is in the front and the low bit is in the behind of the message, the data of data address 0004H is 1388H, and the data of data address 0005H is 0000H.

**CRC** occupies 2 bytes with the fact that the high bit is in the front and the low bit is in the behind.

### 7.3.1.2 Command code: 06H

06H (correspond to binary 0000 0110), write one word (Word)

The command means that the master write data to the inverter and one command can write one data other than multiple dates. The effect is to change the working mode of the inverter.

For example, write 5000 (1388H) to 0004H from the inverter with the address of 02H, the frame structure is as below:

**RTU** master command message (from the master to the inverter)

START	T1-T2-T3-T4
ADDR	02H
CMD	06H
High bit of writing data address	00H
Low bit of writing data address	04H
High bit of data content	13H
Low bit of data content	88H

CRC CHK low bit	C5H
CRC CHK high bit	6EH
END	T1-T2-T3-T4

RTU slave response message (from the inverter to the master)

START	T1-T2-T3-T4
ADDR	02H
CMD	06H
High bit of writing data address	00H
Low bit of writing data address	04H
High bit of data content	13H
Low bit of data content	88H
CRC CHK low bit	C5H
CRC CHK high bit	6EH
END	T1-T2-T3-T4

**Note:** section 10.2 and 10.3 mainly describe the command format, and the detailed application will be mentioned in 10.8 with examples.

### 7.3.1.3 Command code 08H for diagnosis

Meaning of sub-function codes

Sub-function Code	Description
0000	Return to inquire information data

For example: The inquiry information string is same as the response information string when the loop detection to address 01H of driver is carried out.

The RTU request command is:

START	T1-T2-T3-T4
ADDR	01H
CMD	08H
High bit of sub-function code	00H
Low bit of sub-function code	00H
High bit of data content	12H
Low bit of data content	ABH
CRC CHK low bit	ADH
CRC CHK high bit	14H
END	T1-T2-T3-T4

The RTU response command is:

START	T1-T2-T3-T4
ADDR	01H
CMD	08H
High bit of sub-function code	00H
Low bit of sub-function code	00H
High bit of data content	12H
Low bit of data content	ABH
CRC CHK low bit	ADH
CRC CHK high bit	14H
END	T1-T2-T3-T4

### 7.3.1.4 Command code: 10H, continuous writing

Command code 10H means that if the master writes data to the inverter, the data number depends on the "data number" in the command code. The max continuous reading number is 16.

For example, write 5000 (1388H) to 0004H of the inverter whose slave address is 02H and 50 (0032H) to

0005H, the frame structure is as below:

The RTU request command is:

START	T1-T2-T3-T4 (transmission time of 3.5 bytes)
ADDR	02H
CMD	10H
High bit of write data	00H
Low bit of write data	04H
High bit of data number	00H
Low bit of data number	02H
Byte number	04H
High bit of data 0004H	13H
Low bit of data 0004H	88H
High bit of data 0005H	00H
Low bit of data 0005H	32H
Low bit of CRC	C5H
High bit of CRC	6EH
END	T1-T2-T3-T4 (transmission time of 3.5 bytes)

The RTU response command is:

START	T1-T2-T3-T4 (transmission time of 3.5 bytes)
ADDR	02H
CMD	10H
High bit of write data	00H
Low bit of write data	04H
High bit of data number	00H
Low bit of data number	02H
Low bit of CRC	C5H
High bit of CRC	6EH
END	T1-T2-T3-T4 (transmission time of 3.5 bytes)

### 7.3.2 ASCII mode

#### 7.3.2.1 Command code: 03H (0000 0011), read N words (Word) (N ≤ 16)

For instance: As for the inverter whose slave address is 01H, the starting address of internal storage is 0004, read two words continuously, the structure of this frame is listed as below:

ASCII master command message (the command sent from the master to the inverter)		ASCII slave response message (the message sent from the inverter to the master)	
START	':'	START	':'
ADDR	'0'	ADDR	'0'
	'1'		'1'
CMD	'0'	CMD	'0'
	'3'		'3'
High bit of starting address	'0'	Byte number	'0'
	'0'		'4'
Low bit of starting address	'0'	High bit of data address 0004H	'1'
	'4'		'3'
High bit of data number	'0'	Low bit of data address 0004H	'8'
	'0'		'8'
Low bit of data number	'0'	High bit of data address 0005H	'0'
	'2'		'0'
LRC CHK Hi	'F'	Low bit of data address 0005H	'0'

ASCII master command message (the command sent from the master to the inverter)		ASCII slave response message (the message sent from the inverter to the master)	
LRC CHK Lo	'6'		'0'
END Hi	CR	LRC CHK Hi	'5'
END Lo	LF	LRC CHK Lo	'D'
		END Hi	CR
		END Lo	LF

### 7.3.2.2 Command code: 06H (0000 0110), write one word (Word)

For instance: Write 5000 (1388H) to the 0004H address of the inverter whose slave address is 02H, then the structure of this frame is listed as below:

ASCII master command message (the command sent by the master to the inverter)		ASCII slave response message (the message sent by the inverter to the master)	
START	':'	START	':'
ADDR	'0'	ADDR	'0'
	'2'		'2'
CMD	'0'	CMD	'0'
	'6'		'6'
High bit of write data	'0'	High bit of write data	'0'
	'0'		'0'
Low bit of write data	'0'	Low bit of write data	'0'
	'4'		'4'
High bit of data content	'1'	High bit of data content	'1'
	'3'		'3'
Low bit of data content	'8'	Low bit of data content	'8'
	'8'		'8'
LRC CHK Hi	'5'	LRC CHK Hi	'5'
LRC CHK Lo	'9'	LRC CHK Lo	'9'
END Hi	CR	END Hi	CR
END Lo	LF	END Lo	LF

### 7.3.2.3 Command code: 08H (0000 1000), diagnose function

Meaning of sub function code:

Sub function code	Instruction
0000	Return inquiry message data

For instance: carry out circuit detection on drive address 01H, the content of inquiry message word string is the same with response message word string, its format is listed as below:

ASCII master command message (the command sent by the master to the inverter)		ASCII slave response message (the message sent by the inverter to the master)	
START	':'	START	':'
ADDR	'0'	ADDR	'0'
	'1'		'1'
CMD	'0'	CMD	'0'
	'8'		'8'
High bit of write data address	'0'	High bit of write data address	'0'
	'0'		'0'
Low bit of write data address	'0'	Low bit of write data address	'0'
	'0'		'0'

ASCII master command message (the command sent by the master to the inverter)		ASCII slave response message (the message sent by the inverter to the master)	
High bit of data content	'1'	High bit of data content	'1'
	'2'		'2'
Low bit of data content	'A'	Low bit of data content	'A'
	'B'		'B'
LRC CHK Hi	'3'	LRC CHK Hi	'3'
LRC CHK Lo	'A'	LRC CHK Lo	'A'
END Hi	CR	END Hi	CR
END Lo	LF	END Lo	LF

### 7.3.2.4 Command code: 10H, continuous writing function

Command code 10H means the master write data to the inverter, the number of data being written is determined by the command "data number", the max number of continuous writing is 16 words.

For instance: Write 5000 (1388H) to 0004H of the inverter whose slave address is 02H, write 50 (0032H) to 0005H of the inverter whose slave address is 02H, then the structure of this frame is listed as below:

ASCII master command message (the command sent by the master to the inverter)		ASCII slave response message (the message sent by the inverter to the master)	
START	':'	START	':'
ADDR	'0'	ADDR	'0'
	'2'		'2'
CMD	'1'	CMD	'1'
	'0'		'0'
High bit of starting address	'0'	High bit of starting address	'0'
	'0'		'0'
Low bit of starting address	'0'	Low bit of starting address	'0'
	'4'		'4'
High bit of data number	'0'	High bit of data number	'0'
	'0'		'0'
Low bit of data number	'2'	Low bit of data number	'2'
Byte number	'0'	LRC CHK Hi	'E'
	'4'	LRC CHK Lo	'8'
High bit of data 0004H content	'1'	END Hi	CR
	'3'	END Lo	LF
Low bit of data 0004H content	'8'		
	'8'		
High bit of data 0005H content	'0'		
Low bit of data 0005H content	'3'		
	'2'		
LRC CHK Hi	'1'		
LRC CHK Lo	'7'		
END Hi	CR		
END Lo	LF		

## 7.4 The definition of data address

The address definition of the communication data in this part is to control the running of the inverter and get the state information and relative function parameters of the inverter.

#### 7.4.1 The rules of parameter address of the function codes

The parameter address occupies 2 bytes with the fact that the high bit is in the front and the low bit is in the behind. The range of high and low byte are: high byte—00 – ffH; low byte—00 – ffH. The high byte is the group number before the radix point of the function code and the low byte is the number after the radix point. But both the high byte and the low byte should be changed into hex. For example P05.05, the group number before the radix point of the function code is 05, then the high bit of the parameter is 05, the number after the radix point 05, then the low bit of the parameter is 05, then the function code address is 0505H and the parameter address of P10.01 is 0A01H.

Function code <sup>1)</sup>	Name <sup>2)</sup>	Detailed instruction of parameters <sup>3)</sup>	Setting range <sup>4)</sup>	Default value <sup>5)</sup>	Modify <sup>6)</sup>	Serial No. <sup>7)</sup>
P10.00 <sup>8)</sup>	Simple PLC <sup>9)</sup>	0: Stop after running once <sup>10)</sup> 1: Run at the final value after running once 2: Cycle running <sup>11)</sup>	0-2 <sup>12)</sup>	0 <sup>13)</sup>	○ <sup>14)</sup>	354 <sup>15)</sup>
P10.01 <sup>16)</sup>	Simple PLC memory <sup>17)</sup>	0: Power loss without memory <sup>18)</sup> 1: Power loss memory <sup>19)</sup>	0-1 <sup>20)</sup>	0 <sup>21)</sup>	○ <sup>22)</sup>	355 <sup>23)</sup>

**Note:** P29 group is the factory parameter which cannot be read or changed. Some parameters cannot be changed when the inverter is in the running state and some parameters cannot be changed in any state. The setting range, unit and relative instructions should be paid attention to when modifying the function code parameters.

Besides, EEPROM is stocked frequently, which may shorten the usage time of EEPROM. For users, some functions are not necessary to be stocked on the communication mode. The needs can be met on by changing the value in RAM. Changing the high bit of the function code form 0 to 1 can also realize the function. For example, the function code P00.07 is not stocked into EEPROM. Only by changing the value in RAM can set the address to 8007H. This address can only be used in writing RAM other than reading. If it is used to read, it is an invalid address.

#### 7.4.2 The address instruction of other function in Modbus

The master can operate on the parameters of the inverter as well as control the inverter, such as running or stopping and monitoring the working state of the inverter.

Below is the parameter list of other functions

Function instruction	Address definition	Data meaning instruction	R/W attribute
Communication control command	2000H	0001H: forward running	W
		0002H: reverse running	
		0003H: forward jogging	
		0004H: reverse jogging	
		0005H: stop	
		0006H: coast to stop (emergency stop)	
		0007H: fault reset	
The address of the communication n setting value	2001H	Communication setting frequency (0 – Fmax(unit: 0.01Hz))	W
	2002H	PID reference, range (0 – 1000, 1000 corresponds to100.0% )	W
	2003H	PID feedback, range (0 – 1000, 1000 corresponds to100.0% )	W
	2004H	Torque setting value (-3000 – 3000, 1000 corresponds to the 100.0% of the rated current of the motor)	W
	2005H	The upper limit frequency setting during forward rotation (0 – Fmax (unit:	W

Function instruction	Address definition	Data meaning instruction	R/W attribute
		0.01Hz))	
	2006H	The upper limit frequency setting during reverse rotation (0 – Fmax (unit: 0.01Hz))	W
	2007H	The upper limit torque of electromotion torque (0 – 3000, 1000 corresponds to the 100.0% of the rated current of the motor)	W
	2008H	The upper limit torque of braking torque (0 – 3000, 1000 corresponds to the 100.0% of the rated current of the motor)	W
	2009H	Special control command word Bit0 – 1: =00: motor 1 =01: motor 2 =10: motor 3 =11: motor 4 Bit2: =1 torque control prohibit =0: torque control prohibit invalid Bit3: =1 power consumption clear =0: no power consumption clear Bit4: =1 pre-exciting =0: pre-exciting prohibition Bit5: =1 DC braking =0: DC braking prohibition	W
	200AH	Virtual input terminal command , range: 0x000 – 0x1FF	W
	200BH	Virtual input terminal command , range: 0x00 – 0x0F	W
	200CH	Voltage setting value (special for V/F separation) (0 – 1000, 1000 corresponds to the 100.0% of the rated voltage of the motor)	W
	200DH	AO output setting 1 (-1000 – 1000, 1000 corresponds to 100.0%)	W
	200EH	AO output setting 2 (-1000 – 1000, 1000 corresponds to 100.0%)	W
SW 1 of the inverter	2100H	0001H: forward running	R
		0002H: forward running	
		0003H: stop	
		0004H: fault	
		0005H: POFF state	
		0006H: pre-exciting state	
SW 1 of the inverter	2101H	Bit0: =0: bus voltage is not established =1: bus voltage is established Bit1 – 2: =00: motor 1 =01: motor 2 =10: motor 3 =11: motor 4 Bit3: =0: asynchronous motor =1: synchronous motor Bit4: =0: pre-alarm without overload =1: overload pre-alarm	R



Function instruction	Address definition	Data meaning instruction	R/W attribute
		Bit5 – Bit6 :=00: keypad control =01: terminal control =10: communication control	
Inverter fault code	2102H	See the fault type instruction	R
Identifying code of the inverter	2103H	MSI20-----0x0106	R
Operation frequency	3000H	Range: 0.00Hz – P00.03	R
Setting frequency	3001H	Range: 0.00Hz – P00.03	R
Bus voltage	3002H	Range: 0 – 2000V	R
Output voltage	3003H	Range: 0 – 1200V	R
Output current	3004H	Range: 0.0 – 3000.0A	R
Operation speed	3005H	Range: 0 – 65535RPM	R
Output power	3006H	Range: -300.0 – 300.0%	R
Output torque	3007H	Range: -250.0 – 250.0%	R
Close loop setting	3008H	Range: -100.0% – 100.0%	R
Close loop feedback	3009H	Range: -100.0% – 100.0%	R
PID setting	3008H	-100.0 – 100.0% (unit: 0.1%)	R
PID feedback	3009H	-100.0 – 100.0% (unit: 0.1%)	R
Input IO	300AH	000 – 1FF	
Input IO	300BH	000 – 1FF	
AI 1	300CH	Range: 0.00 – 10.00V	R
AI 2	300DH	Range: 0.00 – 10.00V	R
AI 3	300EH	Range: 0.00 – 10.00V	R
AI 4	300FH	Range: -10.00 – 10.00V	R
Read high speed pulse 1 input	3010H	Range: 0.00 – 50.00kHz	R
Read high speed pulse 2 input	3011H	Reserved	R
Read current step of the multi-step speed	3012H	Range: 0 – 15	R
External length	3013H	Range: 0 – 65535	R
External counting value	3014H	Range: 0 – 65535	R
Torque setting	3015H	-300.0 – 300.0% (Unit: 0.1% )	R
Inverter code	3016H		R
Fault code	5000H		R

R/W characteristics means the function is with read and write characteristics. For example, “communication control command” is writing characteristics and control the inverter with writing command (06H). R characteristic can only read other than write and W characteristic can only write other than read.

**Note:** when operating on the inverter with the table above, it is necessary to enable some parameters. For example, the operation of running and stopping, it is necessary to set P00.01 to communication running command channel and set P00.02 to MODBUS communication channel. And when operate on “PID given”, it is necessary to set P09.00 to “MODBUS communication setting”.

The encoding rules for device codes (corresponds to identifying code 2103H of the inverter)

Code high 8bit	Meaning	Code low 8 position	Meaning
01	Goodrive	06	MSI20-EU Vector Inverter

**Note:** the code is consisted of 16 bit which is high 8 bits and low 8 bits. High 8 bits mean the motor type series and low 8 bits mean the derived motor types of the series. For example, 0110H means MSI20-EU

vector inverters.

### 7.4.3 Fieldbus ratio values

The communication data is expressed by hex in actual application and there is no radix point in hex. For example, 50.12Hz cannot be expressed by hex so 50.12 can be magnified by 100 times into 5012, so hex 1394H can be used to express 50.12.

A non-integer can be timed by a multiple to get an integer and the integer can be called fieldbus ratio values.

The fieldbus ratio values are referred to the radix point of the setting range or default value in the function parameter list. If there are figures behind the radix point ( $n=1$ ), then the fieldbus ratio value  $m$  is  $10^n$ . Take the table as the example:

Function code <sup>Ⓜ</sup>	Name <sup>Ⓜ</sup>	Detailed instruction of parameters <sup>Ⓜ</sup>	Setting range	Default value <sup>Ⓜ</sup>	Modify	Serial No. <sup>Ⓜ</sup>
P01.20 <sup>Ⓜ</sup>	Hibernation restore delay time <sup>Ⓜ</sup>	0.0~3600.0s (valid when P01.19=2) <sup>Ⓜ</sup>	0.0~3600.0 <sup>Ⓜ</sup>	0.0s <sup>Ⓜ</sup>	<input type="radio"/>	39 <sup>Ⓜ</sup>
P01.21 <sup>Ⓜ</sup>	Restart after power off <sup>Ⓜ</sup>	0: Disable <sup>Ⓜ</sup> 1: Enable <sup>Ⓜ</sup>	0~1 <sup>Ⓜ</sup>	0 <sup>Ⓜ</sup>	<input type="radio"/>	40 <sup>Ⓜ</sup>

If there is one figure behind the radix point in the setting range or the default value, then the fieldbus ratio value is 10. If the data received by the upper monitor is 50, then the "hibernation restore delay time" is 5.0 ( $5.0=50\div 10$ ).

If Modbus communication is used to control the hibernation restore delay time as 5.0s. Firstly, 5.0 can be magnified by 10 times to integer 50 (32H) and then this data can be sent.

01  
inverter address
06  
read command
01 14  
parameters address
00 32  
data number
49 E7  
CRC check

After the inverter receives the command, it will change 50 into 5 according to the fieldbus ratio value and then set the hibernation restore delay time as 5s.

Another example, after the upper monitor sends the command of reading the parameter of hibernation restore delay time, if the response message of the inverter is as following:

01  
inverter address
03  
read command
02  
2 bytes data
00 32  
parameter data
39 91  
CRC check

Because the parameter data is 0032H (50) and 50 divided by 10 is 5, then the hibernation restore delay time is 5s.

### 7.4.4 Fault message response

There may be fault in the communication control. For example, some parameter can only be read. If a writing message is sent, the inverter will return a fault response message.

The fault message is from the inverter to the master, its code and meaning is as below:

Code	Name	Meaning
01H	Illegal command	The command from master cannot be executed. The reason maybe: 1. This command is only for new version and this version cannot realize. 2. Slave is in fault state and cannot execute it.
02H	Illegal data address.	Some of the operation addresses are invalid or not allowed to access. Especially the combination of the register and the transmitting bytes are invalid.
03H	Illegal value	When there are invalid data in the message framed

Code	Name	Meaning
		received by slave. <b>Note:</b> This error code does not indicate the data value to write exceed the range, but indicate the message frame is an illegal frame.
04H	Operation failed	The parameter setting in parameter writing is invalid. For example, the function input terminal cannot be set repeatedly.
05H	Password error	The password written to the password check address is not same as the password set by P7.00.
06H	Data frame error	In the frame message sent by the upper monitor, the length of the digital frame is incorrect or the counting of CRC check bit in RTU is different from the lower monitor.
07H	Written not allowed.	It only happen in write command, the reason maybe: 1. The written data exceeds the parameter range. 2. The parameter should not be modified now. 3. The terminal has already been used.
08H	The parameter cannot be modified during running	The modified parameter in the writing of the upper monitor cannot be modified during running.
09H	Password protection	When the upper monitor is writing or reading and the user password is set without password unlocking, it will report that the system is locked.

The slave uses functional code fields and fault addresses to indicate it is a normal response or some error occurs (named as objection response). For normal responses, the slave shows corresponding function codes, digital address or sub-function codes as the response. For objection responses, the slave returns a code which equals the normal code, but the first byte is logic 1.

For example: when the master sends a message to the slave, requiring it to read a group of address data of the inverter function codes, there will be following function codes:

0 0 0 0 0 1 1 (Hex 03H)

For normal responses, the slave responds the same codes, while for objection responses, it will return:

1 0 0 0 0 1 1 (Hex 83H)

Besides the function codes modification for the objection fault, the slave will respond a byte of abnormal code which defines the error reason.

When the master receives the response for the objection, in a typical processing, it will send the message again or modify the corresponding order.

For example, set the "running command channel" of the inverter (P00.01, parameter address is 0001H) with the address of 01H to 03, the command is as following:

01 06 00 01 00 03 98 0B  
inverter address    read command    parameter address    parameter data    CRC check

But the setting range of "running command channel" is 0 – 2, if it is set to 3, because the number is beyond the range, the inverter will return fault response message as below:

01 86 04 43 A3  
inverter address    abnormal response code    fault code    CRC check

Abnormal response code 86H means the abnormal response to writing command 06H; the fault code is 04H. In the table above, its name is operation failed and its meaning is that the parameter setting in parameter writing is invalid. For example, the function input terminal cannot be set repeatedly.

## 7.5 Example of writing and reading

Refer to section 7.3 for the command format.

### 7.5.1 Example of reading command 03H

Example 1: read the state word 1 of the inverter with the address of 01H (refer to table 1). From the table 1, the parameter address of the state word 1 of the inverter is 2100H.

**RTU mode:**

The command sent to the inverter:

<b>01</b>	<b>03</b>	<b>21 00</b>	<b>00 01</b>	<b>8E 36</b>
Inverter address	Read command	Parameters address	Data number	CRC check

If the response message is as below:

<b>01</b>	<b>03</b>	<b>02</b>	<b>00 03</b>	<b>F8 45</b>
Inverter address	Read command	Data address	Data content	CRC check

**ASCII mode:**

The command sent to the inverter:

:	<b>01</b>	<b>03</b>	<b>21 00</b>	<b>00 01</b>	<b>DA</b>	<b>CR LF</b>
START	Inverter address	Read command	Parameters address	Data number	LRC check	END

If the response message is as below:

:	<b>01</b>	<b>03</b>	<b>02</b>	<b>00 03</b>	<b>F7</b>	<b>CR LF</b>
START	Inverter address	Read command	Byte number	Data content	LRC check	END

The data content is 0003H. From the table 1, the inverter stops.

### 7.5.2 Example of writing command 06H

Example 1: make the inverter with the address of 03H to run forward. See table 1, the address of "communication control command" is 2000H and forward running is 0001. See the table below.

Function instruction	Address definition	Data meaning instruction	R/W characteristics
Communication control command	2000H	0001H: forward running	W/R
		0002H: reverse running	
		0003H: forward jogging	
		0004H: reverse jogging	
		0005H: stop	
		0006H: coast to stop (emergency stop)	
		0007H: fault reset	
		0008H: jogging stop	

**RTU mode:**

The command sent by the master:

<b>03</b>	<b>06</b>	<b>20 00</b>	<b>00 01</b>	<b>42 28</b>
Inverter address	Write command	Parameters address	Forward running	CRC check

If the operation is successful, the response may be as below (the same with the command sent by the master):

<b>03</b>	<b>06</b>	<b>20 00</b>	<b>00 01</b>	<b>42 28</b>
Inverter address	Write command	Parameters address	Forward running	CRC check

### ASCII mode:

The command sent to the inverter:

```

: 01 06 20 00 00 01 D6 CR LF
START Inverter Write Parameters Data LRC
      address command address number check END
  
```

If the response message is as below:

```

: 01 06 20 00 00 01 D6 CR LF
START Inverter Write Parameters Data LRC
      address command address number check END
  
```

Example 2: set the max output frequency of the inverter with the address of 03H as 100Hz.

Function code <sup>1)</sup>	Name <sup>2)</sup>	Detailed instruction of parameters <sup>3)</sup>	Setting range	Default value <sup>4)</sup>	Modify <sup>5)</sup>	Serial No. <sup>6)</sup>
P00.03 <sup>7)</sup>	Max. output frequency <sup>8)</sup>	P00.04~600.00Hz (400.00Hz) <sup>9)</sup>	10.00~600.00 <sup>10)</sup>	50.00Hz <sup>11)</sup>	⊙ <sup>12)</sup>	3 <sup>13)</sup>

See the figures behind the radix point, the fieldbus ratio value of the Max output frequency (P00.03) is 100. 100Hz timed by 100 is 10000 and the corresponding hex is 2710H.

### RTU mode:

The command sent by the master:

```

03 06 00 03 27 10 62 14
Inverter Write Parameters Forward running CRC check
address command address number check
  
```

If the operation is successful, the response may be as below (the same with the command sent by the master):

```

03 06 00 03 27 10 62 14
Inverter Write Parameters Forward running CRC check
address command address number check
  
```

### ASCII mode:

The command sent to the inverter:

```

: 03 06 00 03 27 10 BD CR LF
START Inverter Write Parameters Data LRC
      address command address number check END
  
```

If the response message is as below:

```

: 03 06 00 03 27 10 BD CR LF
START Inverter Write Parameters Data LRC
      address command address number check END
  
```

### 7.5.3 Example of continuous writing command 10H

Example 1: make the inverter whose address is 01H run forward at 10Hz. Refer to the instruction of 2000H and 0001. Set the address of "communication setting frequency" is 2001H and 10Hz corresponds to 03E8H. See the table below.

Function instruction	Address definition	Data meaning instruction	R/W attribute
Communication control command	2000H	0001H: forward running	W/R
		0002H: reverse running	
		0003H: forward jogging	
		0004H: reverse jogging	

Function instruction	Address definition	Data meaning instruction	R/W attribute
		0005H: stop	
		0006H: coast to stop (emergency stop)	
		0007H: fault reset	
		0008H: jogging stop	
The address of communication setting	2001H	Communication setting frequency (0 – Fmax (unit: 0.01Hz))	W/R
	2002H	PID given, range (0 – 1000, 1000 corresponds to 100.0%)	

#### RTU mode:

The command sent to the inverter:

01 10 20 00 00 02 04 00 01 03 E8 3B 10  
Inverter address Continuous writing command Parameters address Data number Byte number Forward running 10Hz CRC check

If the response message is as below:

01 10 20 00 00 02 4A 08  
Inverter address Continuous writing command Parameters address Data number CRC check

#### ASCII mode:

The command sent to the inverter:

: 01 10 20 00 00 02 04 00 01 03 E8 BD CR LF  
START Inverter address Continuous writing command Parameters address Data number Byte number Forward running 10Hz LRC check END

If the response message is as below:

: 01 10 20 00 00 02 CD CR LF  
START Inverter address Continuous writing command Parameters address Data number LRC check END

Example 2: set the ACC time of 01H inverter as 10s and the DEC time as 20s

P00.11	ACC time 1	Setting range of P00.11 and P00.12:	Depend on model	○
P00.12	DEC time 1	0.0 – 3600.0s	Depend on model	○

The corresponding address of P00.11 is 000B, the ACC time of 10s corresponds to 0064H, and the DEC time of 20s corresponds to 00C8H.

#### RTU mode:

The command sent to the inverter:

01 10 00 0B 00 02 04 00 64 00 C8 F2 55  
Inverter address Continuous writing command Parameters address Data number Byte number 10s 20s CRC check

If the response message is as below:

01 10 00 0B 00 02 30 0A  
Inverter address Continuous writing command Parameters address Data number CRC check

#### ASCII mode:

The command sent to the inverter:

START	<u>01</u>	<u>10</u>	<u>00 0B</u>	<u>00 02</u>	<u>04 00 64</u>	<u>00 C8 B2</u>	<u>CR LF</u>
	Inverter address	Continuous writing command	Parameters address	Data number	10s 20s	LRC check	END

If the response message is as below:

START	<u>01</u>	<u>10</u>	<u>00 0B</u>	<u>00 02</u>	<u>E2</u>	<u>CR LF</u>
	Inverter address	Continuous writing command	Parameters address	Data number	LRC check	END

**Note:** the blank in the above command is for illustration. The blank cannot be added in the actual application unless the upper monitor can remove the blank by themselves.

## 7.6 Common communication fault

Common communication faults: no response to the communication or the inverter returns abnormal fault.

The possible reason for no response to the communication:

Selecting wrong serial interface, for example, if the converter is COM1, selecting COM2 during the communication

The baud rate, digital bit, end bit and check bit are not the same with the inverter + and - of RS485 are connected in reverse.

The 485 wire cap on the terminal board of the inverter is not plug in. the wire cap in behind the terminal arrangement.



## Appendix A Technical Data

### A.1 Ratings

#### A.1.1 Capacity

Inverter sizing is based on the rated motor current and power. To achieve the rated motor power given in the table, the rated current of the inverter must be higher than or equal to the rated motor current. Also the rated power of the inverter must be higher than or equal to the rated motor power. The power ratings are the same regardless of the supply voltage within one voltage range.

#### Note:

1. The maximum allowed motor shaft power is limited to  $1.5 \cdot P_N$ . If the limit is exceeded, motor torque and current are automatically restricted. The function protects the input bridge of the drive against overload.
2. The ratings apply at ambient temperature of  $40^\circ\text{C}$ .
3. It is important to check that in common DC systems the power flowing through the common DC connection does not exceed  $P_N$ .

#### A.1.2 Derating

The load capacity decreases if the installation site ambient temperature exceeds  $40^\circ\text{C}$ , the altitude exceeds 1000 meters or the switching frequency is changed from 4 kHz to 8, 12 or 15 kHz.

##### A.1.2.1 Temperature derating

In the temperature range  $+40^\circ\text{C} \dots +50^\circ\text{C}$ , the rated output current is decreased by 1% for every additional  $1^\circ\text{C}$ . Refer to the below list for the actual derating.

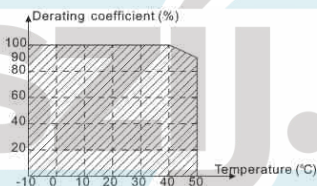

##### A.1.2.2 Altitude derating

The device can output rated power if the installation site below 1000m. The output power decreases if the altitude exceeds 1000 meters. Below is the detailed decreasing range of the derating:

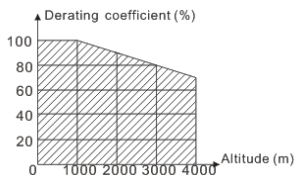

### A.2 CE

#### A.2.1 CE marking

The CE mark is attached to the drive to verify that the drive follows the provisions of the European Low Voltage (2006/95/EC) and EMC Directives (2004/108/EC).

#### A.2.2 Compliance with the European EMC Directive

The EMC Directive defines the requirements for immunity and emissions of electrical equipment used within the European Union. The EMC product standard (EN 61800-3:2004) covers requirements stated for drives. See section *EMC regulations*



### A.3 EMC regulations

EMC product standard (EN 61800-3:2004) contains the EMC requirements to the inverter.

First environment: domestic environment (includes establishments connected to a low-voltage network which supplies buildings used for domestic purposes).

Second environment includes establishments connected to a network not directly supplying domestic premises.

Four categories of the inverter:

Inverter of category C1: inverter of rated voltage less than 1000 V and used in the first environment.

Inverter of category C2: inverter of rated voltage less than 1000 V other than pins, sockets and motion devices and intended to be installed and commissioned only by a professional electrician when used in the first environment.

**Note:** IEC/EN 61800-3 in EMC standard doesn't limit the power distribution of the inverter, but it defines the upstage, installation and commission. The professional electrician has necessary skills in installing and/or commissioning power drive systems, including their EMC aspects.

Inverter of category C3: inverter of rated voltage less than 1000 V and used in the second environment other than the first one

Inverter of category C4: inverter of rated voltage more than 1000 V or the nominal current is above or equal to 400A and used in the complicated system in second environment

#### A.3.1 Category C2

The emission limits are complied with the following provisions:

1. The optional EMC filter is selected according to the options and installed as specified in the EMC filter manual.
2. The motor and control cables are selected as specified in this manual.
3. The drive is installed according to the instructions given in this manual.

	⚡ <b>In a domestic environment, this product may cause radio inference, in which case supplementary mitigation measures may be required.</b>
-----------------------------------------------------------------------------------	----------------------------------------------------------------------------------------------------------------------------------------------

#### A.3.2 Category C3

The immunity performance of the drive complies with the demands of IEC/EN 61800-3, second environment.

The emission limits are complied with the following provisions:

1. The optional EMC filter is selected according to the options and installed as specified in the EMC filter manual.
2. The motor and control cables are selected as specified in this manual.
3. The drive is installed according to the instructions given in this manual.

	⚡ <b>A drive of category C3 is not intended to be used on a low-voltage public network which supplies domestic premises. Radio frequency interference is expected if the drive is used on such a network.</b>
-------------------------------------------------------------------------------------	---------------------------------------------------------------------------------------------------------------------------------------------------------------------------------------------------------------

## Appendix B Dimension Drawings

Dimension drawings of the MSI20-EU are shown below. The dimensions are given in millimeters and inches.

### B.1 External keypad structure

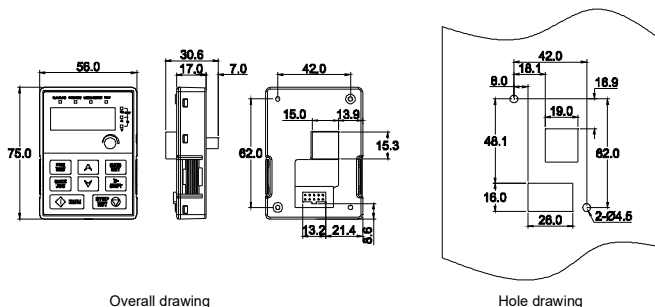

Overall drawing

Hole drawing

Note: The external keypad is optional for the inverters (1PH 230V/3PH 400V  $\leq 2.2\text{kW}$  and 3PH 230V  $\leq 0.75\text{kW}$ ); the standard keypad of inverters (3PH 400V  $\geq 4\text{kW}$  and 3PH 230V  $\geq 1.5\text{kW}$ ) can be used as the external keypad.

The keypad can be installed on the bracket if it is external.

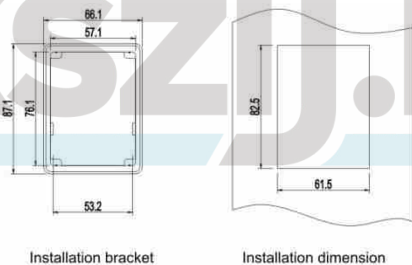

Installation bracket

Installation dimension

### B.2 Inverter chart

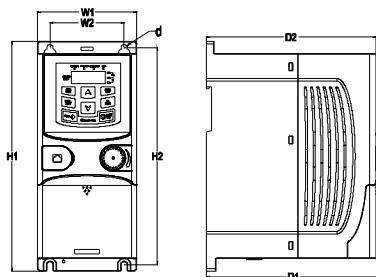

Wall mounting of 0.75 – 2.2kW inverters (Dimension (unit: mm))

Model	W1	W2	H1	H2	D1	D2	Installation hole (d)
MSI20-004-S2-EU	80.0	60.0	160.0	150.0	123.5	120.3	5
MSI20-007-S2-EU	80.0	60.0	160.0	150.0	123.5	120.3	5
MSI20-015-S2-EU	80.0	60.0	185.0	175.0	140.5	137.3	5
MSI20-022-S2-EU	80.0	60.0	185.0	175.0	140.5	137.3	5
MSI20-004-2-EU	80.0	60.0	185.0	175.0	140.5	137.3	5
MSI20-007-2-EU	80.0	60.0	185.0	175.0	140.5	137.3	5
MSI20-0R7G-4-EU	80.0	60.0	185.0	175.0	140.5	137.3	5
MSI20-1R5G-4-EU	80.0	60.0	185.0	175.0	140.5	137.3	5
MSI20-2R2G-4-EU	80.0	60.0	185.0	175.0	140.5	137.3	5

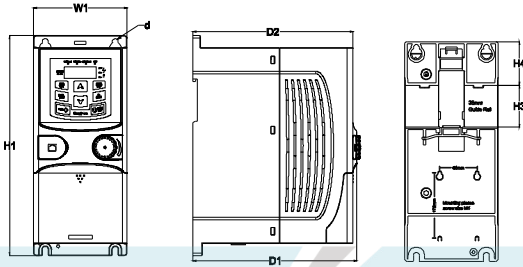

Rail mounting of inverters of 1PH 220V/3PH 380V ( $\leq 2.2\text{kW}$ ) and 3PH 220V ( $\leq 0.75\text{kW}$ )

Dimension (unit: mm)

Model	W1	H1	H3	H4	D1	D2	Installation hole (d)
MSI20-004-S2-EU	80.0	160.0	35.4	36.6	123.5	120.3	5
MSI20-007-S2-EU	80.0	160.0	35.4	36.6	123.5	120.3	5
MSI20-015-S2-EU	80.0	185.0	35.4	36.6	140.5	137.3	5
MSI20-022-S2-EU	80.0	185.0	35.4	36.6	140.5	137.3	5
MSI20-0R4G-2-EU	80.0	185.0	35.4	36.6	140.5	137.3	5
MSI20-0R7G-2-EU	80.0	185.0	35.4	36.6	140.5	137.3	5
MSI20-0R7G-4-EU	80.0	185.0	35.4	36.6	140.5	137.3	5
MSI20-1R5G-4-EU	80.0	185.0	35.4	36.6	140.5	137.3	5
MSI20-2R2G-4-EU	80.0	185.0	35.4	36.6	140.5	137.3	5

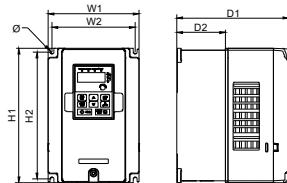

Wall mounting of 3PH 400V 4 – 37kW and 3PH 230V 1.5 – 7.5 kW inverters

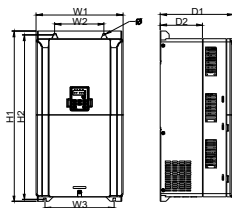

Wall mounting of 3PH 400V 45 – 75kW inverters

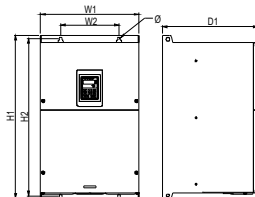

Wall mounting of 3PH 400V 90 – 110kW inverters (Dimension (unit: mm))

Model	W1	W2	W3	H1	H2	D1	D2	Installation hole
MSI20-1R5G-2-EU	146.0	131.0	—	256.0	243.5	167.0	84.5	6
MSI20-2R2G-2-EU	146.0	131.0	—	256.0	243.5	167.0	84.5	6
MSI20-004G-2-EU	146.0	131.0	—	256.0	243.5	167.0	84.5	6
MSI20-5R5G-2-EU	170.0	151.0	—	320.0	303.5	196.3	113.0	6
MSI20-7R5G-2-EU	170.0	151.0	—	320.0	303.5	196.3	113.0	6
MSI20-004G-4-EU	146.0	131.0	—	256.0	243.5	167.0	84.5	6
MSI20-5R5G-4-EU	146.0	131.0	—	256.0	243.5	167.0	84.5	6
MSI20-7R5G-4-EU	170.0	151.0	—	320.0	303.5	196.3	113.0	6
MSI20-011G-4-EU	170.0	151.0	—	320.0	303.5	196.3	113.0	6
MSI20-015G-4-EU	170.0	151.0	—	320.0	303.5	196.3	113.0	6
MSI20-018G-4-EU	200.0	185.0	—	340.6	328.6	184.3	104.5	6
MSI20-022G-4-EU	200.0	185.0	—	340.6	328.6	184.3	104.5	6
MSI20-030G-4-EU	250.0	230.0	—	400.0	380.0	202.0	123.5	6
MSI20-037G-4-EU	250.0	230.0	—	400.0	380.0	202.0	123.5	6
MSI20-045G-4-EU	282.0	160.0	226.0	560.0	542.0	238.0	138.0	9
MSI20-055G-4-EU	282.0	160.0	226.0	560.0	542.0	238.0	138.0	9
MSI20-075G-4-EU	282.0	160.0	226.0	560.0	542.0	238.0	138.0	9
MSI20-090G-4-EU	338.0	200.0	—	554.0	535.0	329.2	—	9.5
MSI20-110G-4-EU	338.0	200.0	—	554.0	535.0	329.2	—	9.5

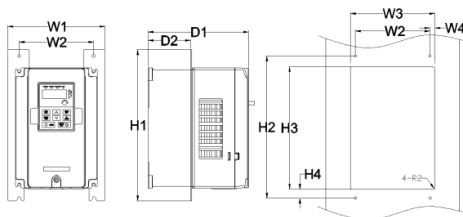

Flange mounting of 3PH 400V 4 – 75kW and 3PH 230V 1.5 – 7.5kW inverters

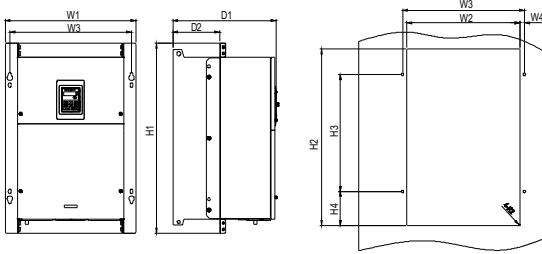

Flange mounting of 3PH 400V 90 – 110kW inverters

Dimension (unit: mm)

Model	W1	W2	W3	W4	H1	H2	H3	H4	D1	D2	Installation hole	Screw
MSI20-1R5G-2-EU	170.2	131	150	9.5	292	276	260	6	167	84.5	6	M5
MSI20-2R2G-2-EU	170.2	131	150	9.5	292	276	260	6	167	84.5	6	M5
MSI20-4R0G-2-EU	170.2	131	150	9.5	292	276	260	6	167	84.5	6	M5
MSI20-5R5G-2-EU	191.2	151	174	11.5	370	351	324	12	196.3	113	6	M5
MSI20-7R5G-2-EU	191.2	151	174	11.5	370	351	324	12	196.3	113	6	M5
MSI20-004G-4-EU	170.2	131	150	9.5	292	276	260	6	167	84.5	6	M5
MSI20-5R5G-4-EU	170.2	131	150	9.5	292	276	260	6	167	84.5	6	M5
MSI20-7R5G-4-EU	191.2	151	174	11.5	370	351	324	12	196.3	113	6	M5
MSI20-011G-4-EU	191.2	151	174	11.5	370	351	324	12	196.3	113	6	M5
MSI20-015G-4-EU	191.2	151	174	11.5	370	351	324	12	196.3	113	6	M5
MSI20-018G-4-EU	266	250	224	13	371	250	350.6	20.3	184.6	104	6	M5
MSI20-022G-4-EU	266	250	224	13	371	250	350.6	20.3	184.6	104	6	M5
MSI20-030G-4-EU	316	300	274	13	430	300	410	55	202	118.3	6	M5
MSI20-037G-4-EU	316	300	274	13	430	300	410	55	202	118.3	6	M5
MSI20-045G-4-EU	352	332	306	13	580	400	570	80	238	133.8	9	M8
MSI20-055G-4-EU	352	332	306	13	580	400	570	80	238	133.8	9	M8
MSI20-075G-4-EU	352	332	306	13	580	400	570	80	238	133.8	9	M8
MSI20-090G-4-EU	418.5	361	389.5	14.2	600	559	370	108.5	329.5	149.5	9.5	M8
MSI20-110G-4-EU	418.5	361	389.5	14.2	600	559	370	108.5	329.5	149.5	9.5	M8

Note: The installation bracket is optional.

## Appendix C Peripheral Options and Parts



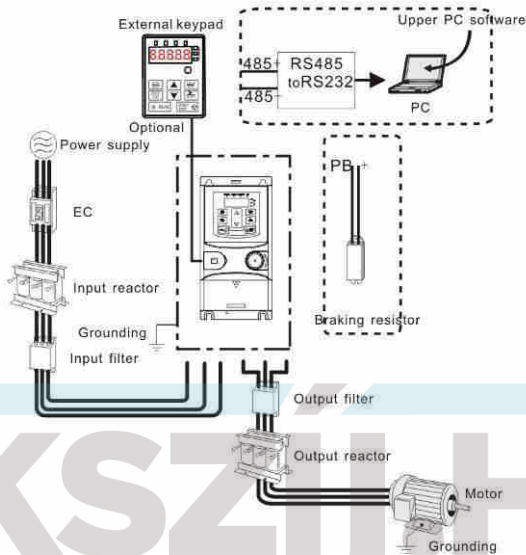

This chapter describes how to select the options and parts of MSI20-EU series.

### C.1 Peripheral wiring

Below is the peripheral wiring of MSI20-EU series inverters.



Pictures	Name	Descriptions
	External keypad	Including the external keypads with and without the function of parameter copying. When the external keypad with the function of parameter copying is valid, the local keypad is off; when the external keypad without the function of parameter copying is valid, the local and external keypads are on at the same time.
	Cables	Device to transfer the electronic signals
	Breaker	Prevent from electric shock and protect the power supply and the cables system from overcurrent when short circuits occur. (Please select the breaker with the function of reducing high order harmonic and the rated sensitive current to 1 inverter should be above 30mA).
	Input reactor	This device is used to improve the power factor of the input side of the inverter and control the higher harmonic current.

Pictures	Name	Descriptions
	Input filter	Control the electromagnetic interference generated from the inverter, please install close to the input terminal side of the inverter.
	Braking resistors	Shorten the DEC time. Only braking resistors are needed for MSI20-EU inverters.
	Output filter	Control the interference from the output side of the inverter and please install close to the output terminals of the inverter.
	Output reactor	Prolong the effective transmitting distance of the inverter to control the sudden high voltage when switching on/off the IGBT of the inverter.
	Membrane of heat releasing holes at the side	Apply to severe environment and improve protective effect. Derate 10% of the machine.

## C.2 Power supply

	⚡ Check that the voltage degree of the inverter complies with the voltage of the supply power voltage.
-----------------------------------------------------------------------------------	--------------------------------------------------------------------------------------------------------

## C.3 Cables

### C.3.1 Power cables

Dimension the input power and motor cables according to local regulations.

**Note:** A separate PE conductor is required if the conductivity of the cable shield is not sufficient for the purpose.

### C.3.2 Control cables

All analog control cables and the cable used for the frequency input must be shielded.

The relay cable needs the cable type with braided metallic screen.

**Note:** Run analog and digital signals in separate cables.

Check the insulation of the input power cable according to local regulations before connecting to the drive.

Model	Recommended cable size (mm <sup>2</sup> )		Connecting cable size (mm <sup>2</sup> )			Terminal screw	Tightening torque (Nm)
	RST	PE	RST	P1, (+)	PE		
	UVW		UVW				
MSI20-004-S2-EU	1.5	1.5	1-4	1-4	1-4	M3	0.8
MSI20-007-S2-EU	1.5	1.5	1-4	1-4	1-4	M3	0.8
MSI20-015-S2-EU	2.5	2.5	1-4	1-4	1-4	M3	0.8
MSI20-022-S2-EU	2.5	2.5	1-4	1-4	1-4	M3	0.8
MSI20-0R4G-2-EU	1.5	1.5	1-1.5	1-1.5	1-1.5	M3	0.8
MSI20-0R7G-2-EU	1.5	1.5	1-1.5	1-1.5	1-1.5	M3	0.8
MSI20-1R5G-2-EU	2.5	2.5	1.5-6	2.5-6	2.5-6	M4	1.13
MSI20-2R2G-2-EU	2.5	2.5	1.5-6	2.5-6	2.5-6	M4	1.13
MSI20-4R0G-2-EU	2.5	2.5	1.5-6	2.5-6	2.5-6	M4	1.13
MSI20-5R5G-2-EU	4	4	4-10	4-10	4-10	M5	2.3
MSI20-7R5G-2-EU	6	6	4-10	4-10	4-10	M5	2.3
MSI20-0R7G-4-EU	1.5	1.5	1-1.5	1-1.5	1-1.5	M3	0.8

Model	Recommended cable size (mm <sup>2</sup> )		Connecting cable size (mm <sup>2</sup> )			Terminal screw	Tightening torque (Nm)
	RST	PE	RST	P1, (+)	PE		
	UVW		UVW				
MSI20-1R5G-4-EU	1.5	1.5	1-1.5	1-1.5	1-1.5	M3	0.8
MSI20-2R2G-4-EU	1.5	1.5	1-1.5	1-1.5	1-1.5	M3	0.8
MSI20-4R0G-4-EU	2.5	2.5	2.5 – 6	2.5 – 6	2.5 – 6	M4	1.13
MSI20-5R5G-4-EU	2.5	2.5	2.5 – 6	2.5 – 6	2.5 – 6	M4	1.13
MSI20-7R5G-4-EU	4	4	4 – 10	4 – 10	4 – 10	M5	2.3
MSI20-011G-4-EU	6	6	4 – 10	4 – 10	4 – 10	M5	2.3
MSI20-015G-4-EU	6	6	4 – 10	4 – 10	4 – 10	M5	2.3
MSI20-018G-4-EU	10	10	10 – 16	10 – 16	10 – 16	M5	2.3
MSI20-022G-4-EU	16	16	10 – 16	10 – 16	10 – 16	M5	2.3
MSI20-030G-4-EU	25	16	25 – 50	25 – 50	16 – 25	M6	2.5
MSI20-037G-4-EU	25	16	25 – 50	25 – 50	16 – 25	M6	2.5
MSI20-045G-4-EU	35	16	35 – 70	35 – 70	16 – 35	M8	10
MSI20-055G-4-EU	50	25	35 – 70	35 – 70	16 – 35	M8	10
MSI20-075G-4-EU	70	35	35 – 70	35 – 70	16 – 35	M8	10
MSI20-090G-4-EU	95	50	70 – 120	70 – 120	50 – 70	M12	35
MSI20-110G-4-EU	120	70	70 – 120	70 – 120	50 – 70	M12	35

**Note:**

1. It is appropriate to use the recommended cable size under 40°C and rated current. The wiring distance should be no more than 100m..
2. Terminals P1, (+), PB and (-) connects the DC reactor options and parts.

**C.4 Breaker and electromagnetic contactor**

It is necessary to add fuse for the avoidance of overload.

It is appropriate to use a breaker (MCCB) which complies with the inverter power in the 3-phase AC power and input power and terminals. The capacity of the breaker should be 1.5-2 times of the rated current.

	<p>⚡ <b>Due to the inherent operating principle and construction of circuit breakers, independent of the manufacturer, hot ionized gases may escape from the breaker enclosure in case of a short-circuit. To ensure safe use, special attention must be paid to the installation and placement of the breakers. Follow the manufacturer's instructions.</b></p>
--	------------------------------------------------------------------------------------------------------------------------------------------------------------------------------------------------------------------------------------------------------------------------------------------------------------------------------------------------------------------

It is necessary to install the electromagnetic contactor in the input side to control the switching on and off safety of the main circuit. It can switch off the input power supply when system faults.

Model	Fuse (A)	Breaker (A)	Rated working current of the contactor (A)
MSI20-004-S2-EU	10	10	9
MSI20-007-S2-EU	16	16	12
MSI20-015-S2-EU	25	25	25
MSI20-022-S2-EU	50	40	32
MSI20-0R4G-2-EU	6	6	9
MSI20-0R7G-2-EU	10	10	9
MSI20-1R5G-2-EU	16	16	12
MSI20-2R2G-2-EU	25	25	18
MSI20-4R0G-2-EU	35	32	25
MSI20-5R5G-2-EU	35	32	32



Model	Fuse (A)	Breaker (A)	Rated working current of the contactor (A)
MSI20-7R5G-2-EU	50	63	50
MSI20-0R7G-4-EU	6	6	9
MSI20-1R5G-4-EU	10	10	9
MSI20-2R2G-4-EU	10	10	9
MSI20-4R0G-4-EU	25	25	25
MSI20-5R5G-4-EU	35	32	25
MSI20-7R5G-4-EU	50	40	38
MSI20-011G-4-EU	63	63	50
MSI20-015G-4-EU	63	63	50
MSI20-018G-4-EU	100	100	65
MSI20-022G-4-EU	100	100	80
MSI20-030G-4-EU	125	125	95
MSI20-037G-4-EU	150	160	115
MSI20-045G-4-EU	150	200	170
MSI20-055G-4-EU	200	200	170
MSI20-075G-4-EU	250	250	205
MSI20-090G-4-EU	325	315	245
MSI20-110G-4-EU	350	350	300

### C.5 Reactors

Transient high current in the input power circuit may cause damage to the rectifying components. It is appropriate to use AC reactor in the input side for the avoidance of high-voltage input of the power supply and improvement of the power factors.

If the distance between the inverter and the motor is longer than 50m, frequent overcurrent protection may occur to the inverter because of high leakage current caused by parasitic capacitance effects from the long cables to the ground. In order to avoid the damage of the motor insulation, it is necessary to add reactor compensation. If the distance between the inverter and motor is 50 – 100m, see the table below for model selection; if it exceeds 100m, consult with MORGENSEN technical support.

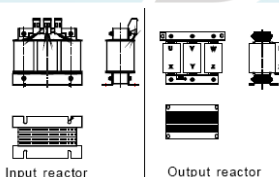

Model	Input reactor	Output reactor
MSI20-004-S2-EU		
MSI20-007-S2-EU		
MSI20-015-S2-EU		
MSI20-022-S2-EU		
MSI20-0R4G-2-EU	ACL2-1R5-4	OCL2-1R5-4
MSI20-0R7G-2-EU	ACL2-1R5-4	OCL2-1R5-4
MSI20-1R5G-2-EU	ACL2-004-4	OCL2-004-4
MSI20-2R2G-2-EU	ACL2-004-4	OCL2-004-4
MSI20-4R0G-2-EU	ACL2-5R5-4	OCL2-5R5-4
MSI20-5R5G-2-EU	ACL2-7R5-4	OCL2-7R5-4
MSI20-7R5G-2-EU	ACL2-015-4	OCL2-015-4
MSI20-0R7G-4-EU	ACL2-1R5-4	OCL2-1R5-4

Model	Input reactor	Output reactor
MSI20-1R5G-4-EU	ACL2-1R5-4	OCL2-1R5-4
MSI20-2R2G-4-EU	ACL2-2R2-4	OCL2-2R2-4
MSI20-4R0G-4-EU	ACL2-004-4	OCL2-004-4
MSI20-5R5G-4-EU	ACL2-5R5-4	OCL2-5R5-4
MSI20-7R5G-4-EU	ACL2-7R5-4	OCL2-7R5-4
MSI20-011G-4-EU	ACL2-011-4	OCL2-011-4
MSI20-015G-4-EU	ACL2-015-4	OCL2-015-4
MSI20-018G-4-EU	ACL2-018-4	OCL2-018-4
MSI20-022G-4-EU	ACL2-022-4	OCL2-022-4
MSI20-030G-4-EU	ACL2-030-4	OCL2-030-4
MSI20-037G-4-EU	ACL2-037-4	OCL2-037-4
MSI20-045G-4-EU	ACL2-045-4	OCL2-045-4
MSI20-055G-4-EU	ACL2-055-4	OCL2-055-4
MSI20-075G-4-EU	ACL2-075-4	OCL2-075-4
MSI20-090G-4-EU	ACL2-110-4	OCL2-110-4
MSI20-110G-4-EU	ACL2-110-4	OCL2-110-4

**Note:**

The rated derate voltage of the input reactor is 2%±15%. The rated derate voltage of the output reactor is 1%±15%. Above options are external, the customer should indicate when purchasing.

**C.6 Filter**

**C.6.1 C3 Filter type instruction**

  
**FLT-P04003L-C-G**
  
A
B
C
D
E
F
G

Character designation	Detailed instruction
A	FLT: inverter filter series
B	Filter type P: power supply filter L: output filter
C	Voltage degree S2: AC 1PH 220V(-15%) – 240V(+10%) 04: AC 3PH 380V (-15%) – 440V(+10%)
D	3-digit development serial number. For example, 003 stands for the serial number of C3 filters in development
E	Installation type L: Common type H: High performance type
F	Utilization environment of the filters A: the first environment (IEC61800-3:2004) category C1 (EN 61800-3:2004) B: the first environment (IEC61800-3:2004) category C2 (EN 61800-3:2004) C: the second environment (IEC61800-3:2004) category C3 (EN 61800-3:2004)
G	Lot No. G: Special for external C3 filter

### C.6.2 C3 filter

For 1PH 230V/3PH 400V 2.2kW and below/3PH 230V 0.75kW and below models, they can comply with IEC61800-3 class C3 by installing external filter (optional) as table below shows. While for 3PH 400V 4kW and above/3PH 230V 1.5kW and above models, they can choose whether to comply with IEC6180-3 class C3 by jumper J10.

**(Note: Jumper J10 is in the same packing bag with the instruction manual)**

Note: Disconnect J10 when the following situations occur:

1. As EMC filter is suitable for the neutral grounding grid system, disconnect jumper J10 if EMC filter is applied in IT grid system;
2. Disconnect jumper J10 if tripping occurred at startup during configuring residual current circuit-breaker.

Input interference filter: The inverter may interfere with surrounding devices via cables during operation, while the interference filter can reduce the interference effectively.

Output noise filter: It is used to decrease the radio noise caused by cables between the inverter and motor and the leakage current of the lead wires.

Our company configured some filters for the convenient of the users.

Model	Input filter
MSI20-004-S2-EU	FLT-PS2004L-C-G
MSI20-007-S2-EU	
MSI20-015-S2-EU	
MSI20-022-S2-EU	
MSI20-0R4G-2-EU	FLT-P04007L-C-G
MSI20-0R7G-2-EU	
MSI20-0R7G-4-EU	
MSI20-1R5G-4-EU	
MSI20-2R2G-4-EU	

Note:

1. The input EMI meet the requirement of C3 after adding input filters.
2. Above options are external, the customer should indicate when purchasing.

### C.6.3 Installation instruction for C3 filter

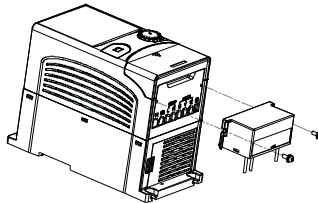

The installation procedures for C3 filter are as below:

1. Connect the filter cable to the corresponding input terminal of the inverter according to the label;
2. Fix the filter onto the inverter with M3\*10 screws (as shown in above picture).

### C.6.4 C2 Filter type instruction

## FLT-P04016L-B

A
B
C
D
E
F

Character designation	Detailed instruction
A	FLT: inverter filter series
B	Filter type P: power supply filter L: output filter
C	Voltage degree S2: AC 1PH 220V(-15%) – 240V(+10%) 04: AC 3PH 380V(-15%) – 440V(+10%)
D	3 bit rated current code "016" means 16A
E	Installation type L: Common type H: High performance type
F	Utilization environment of the filters A: the first environment (IEC61800-3:2004) category C1 (EN 61800-3:2004) B: the first environment (IEC61800-3:2004) category C2 (EN 61800-3:2004)

### C.6.5 C2 filter

Model	Input filter	Output filter
MSI20-004-S2-EU	FLT-PS2010H-B	FLT-L04006L-B
MSI20-007-S2-EU		
MSI20-015-S2-EU	FLT-PS2025L-B	FLT-L04016L-B
MSI20-022-S2-EU		
MSI20-0R4G-2-EU	FLT-P04006L-B	FLT-L04006L-B
MSI20-0R7G-2-EU		
MSI20-1R5G-2-EU	FLT-P04016L-B	FLT-L04016L-B
MSI20-2R2G-2-EU		
MSI20-4R0G-2-EU	FLT-P04032L-B	FLT-L04032L-B
MSI20-5R5G-2-EU		
MSI20-7R5G-2-EU	FLT-P04045L-B	FLT-L04045L-B
MSI20-0R7G-4-EU		
MSI20-1R5G-4-EU	FLT-P04006L-B	FLT-L04006L-B
MSI20-2R2G-4-EU		
MSI20-4R0G-4-EU	FLT-P04016L-B	FLT-L04016L-B
MSI20-5R5G-4-EU		
MSI20-7R5G-4-EU	FLT-P04032L-B	FLT-L04032L-B
MSI20-011G-4-EU		
MSI20-015G-4-EU	FLT-P04045L-B	FLT-L04045L-B
MSI20-018G-4-EU		
MSI20-022G-4-EU	FLT-P04065L-B	FLT-L04065L-B
MSI20-030G-4-EU		
MSI20-037G-4-EU	FLT-P04100L-B	FLT-L04100L-B
MSI20-045G-4-EU		
MSI20-055G-4-EU	FLT-P04150L-B	FLT-L04150L-B
MSI20-075G-4-EU		

Model	Input filter	Output filter
MSI20-090G-4-EU	FLT-P04240L-B	FLT-L04240L-B
MSI20-110G-4-EU		

**Note:**

1. The input EMI meet the requirement of C2 after adding input filters.
2. Above options are external, the customer should indicate when purchasing.

**C.7 Braking components**

**C.7.1 Select the braking components**

It is appropriate to use braking resistor or braking unit when the motor brakes sharply or the motor is driven by a high inertia load. The motor will become a generator if its actual rotating speed is higher than the corresponding speed of the reference frequency. As a result, the inertial energy of the motor and load return to the inverter to charge the capacitors in the main DC circuit. When the voltage increases to the limit, damage may occur to the inverter. It is necessary to apply braking unit/resistor to avoid this accident happens.

	<ul style="list-style-type: none"> <li>⚡ <b>Only qualified electricians are allowed to design, install, commission and operate on the inverter.</b></li> <li>⚡ <b>Follow the instructions in “warning” during working. Physical injury or death or serious property may occur.</b></li> <li>⚡ <b>Only qualified electricians are allowed to wire. Damage to the inverter or braking options and part may occur. Read carefully the instructions of braking resistors or units before connecting them with the inverter.</b></li> <li>⚡ <b>Do not connect the braking resistor with other terminals except for PB and (-). Do not connect the braking unit with other terminals except for (+) and (-). Damage to the inverter or braking circuit or fire may occur.</b></li> </ul>
	<ul style="list-style-type: none"> <li>⚡ <b>Connect the braking resistor or braking unit with the inverter according to the diagram. Incorrect wiring may cause damage to the inverter or other devices.</b></li> </ul>

MSI20-EU series inverters have internal braking units.

Model	Type of braking unit	Braking resistor at 100% of braking torque (Ω)	Consumed power of the braking resistor			Min. braking resistor (Ω)
			10% braking	50% braking	80% braking	
MSI20-004-S2-EU	Internal braking unit	361	0.06	0.30	0.48	42
MSI20-007-S2-EU		192	0.11	0.56	0.90	42
MSI20-015-S2-EU		96	0.23	1.10	1.80	30
MSI20-022-S2-EU		65	0.33	1.70	2.64	21
MSI20-0R4G-2-EU		361	0.06	0.3	0.48	131
MSI20-0R7G-2-EU		192	0.11	0.56	0.9	93
MSI20-1R5G-2-EU		96	0.23	1.1	1.8	44
MSI20-2R2G-2-EU		65	0.33	1.7	2.64	44
MSI20-4R0G-2-EU		36	0.6	3	4.8	33
MSI20-5R5G-2-EU		26	0.75	4.13	6.6	25
MSI20-7R5G-2-EU		19	1.13	5.63	9	13
MSI20-0R7G-4-EU		653	0.11	0.56	0.90	240
MSI20-1R5G-4-EU		326	0.23	1.13	1.80	170
MSI20-2R2G-4-EU		222	0.33	1.65	2.64	130

Model	Type of braking unit	Braking resistor at 100% of braking torque ( $\Omega$ )	Consumed power of the braking resistor			Min. braking resistor ( $\Omega$ )
			10% braking	50% braking	80% braking	
MSI20-4R0G-4-EU		122	0.6	3	4.8	80
MSI20-5R5G-4-EU		89.1	0.75	4.13	6.6	60
MSI20-7R5G-4-EU		65.3	1.13	5.63	9	47
MSI20-011G-4-EU		44.5	1.65	8.25	13.2	31
MSI20-015G-4-EU		32.0	2.25	11.3	18	23
MSI20-018G-4-EU		27	3	14	22	19
MSI20-022G-4-EU		22	3	17	26	17
MSI20-030G-4-EU		17	5	23	36	17
MSI20-037G-4-EU		13	6	28	44	11.7
MSI20-045G-4-B-EU		10	7	34	54	8
MSI20-055G-4-B-EU		8	8	41	66	8
MSI20-075G-4-B-EU		6.5	11	56	90	6.4
MSI20-090G-4-B-EU		5.4	14	68	108	4.4
MSI20-110G-4-B-EU		4.5	17	83	132	4.4

**Note:**

Select the resistor and power of the braking unit according to the data our company provided.

The braking resistor may increase the braking torque of the inverter. The resistor power in the above table is designed on 100% braking torque and 10% braking usage ratio. If the users need more braking torque, the braking resistor can decrease properly and the power needs to be magnified.

	⚡ <b>Never use a brake resistor with a resistance below the minimum value specified for the particular drive. The drive and the internal chopper are not able to handle the overcurrent caused by the low resistance.</b>
	⚠ <b>Increase the power of the braking resistor properly in the frequent braking situation (the frequency usage ratio is more than 10%).</b>

**C.7.2 Placing the brake resistor**

Use shielded cables for braking resistor cables.

Install all resistors in a place where they will cool.

	⚡ <b>The materials near the brake resistor must be non-flammable. The surface temperature of the resistor is high. Air flowing from the resistor is of hundreds of degrees Celsius. Protect the resistor against contact.</b>
--	-------------------------------------------------------------------------------------------------------------------------------------------------------------------------------------------------------------------------------

Only external braking resistor is needed in MSI20-EU.

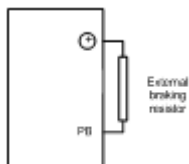

## **Appendix D Further Information**

### **D.1 Product and service inquiry**

Address any inquiries about the product to your local MORGENSEN offices, quoting the type designation and serial number of the unit in question. A listing of MORGENSEN sales, support and service contacts can be found by navigating to [www.morgensen.de](http://www.morgensen.de).

### **D.2 Feedback of MORGENSEN Inverters manuals**

Your comments on our manuals are welcome. Go to [www.morgensen.de](http://www.morgensen.de) and select *Online Feedback of Contact Us*.

### **D.3 Document library on the Internet**

You can find manuals and other product documents in PDF format on the Internet. Go to [www.morgensen.de](http://www.morgensen.de) and select *Service and Support of Document Download*.



**ÉKSZIJ.HU**



**ÉKSZIJ.HU**

**ÉKSZIJ.HU**

**EKSZIJ.HU**

