

VARIABLE SPEED V-BELTS

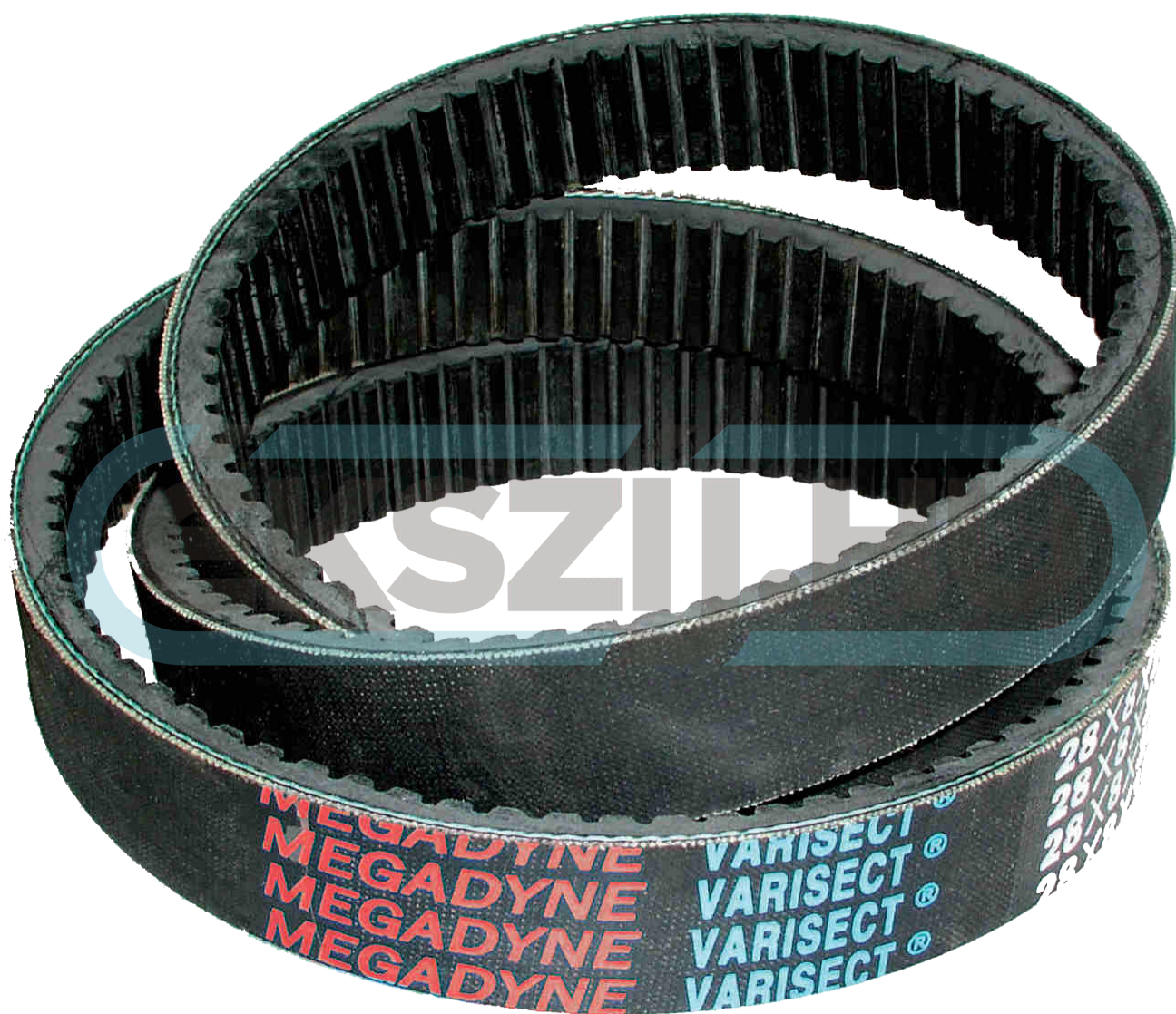

BELT CHARACTERISTICS

section	13x6	17x6	21x7	22x8	26x8	28x8	30x10	32x10	36x12	37x10	42x13	47x13	52x16	55x16	65x20	70x20
w (mm)	13	17	21	22	26	28	30	32	36	37	42	47	52	55	65	70
T (mm)	6	6	7	8	8	8	10	10	12	10	13	13	16	16	20	20
pitch length - internal length = Δi (mm)	29	29	33	38	38	38	47	47	56	47	61	61	75	75	94	94
external length - pitch length = Δe (mm)	9	9	11	12	12	12	16	16	19	16	21	21	25	25	31	31
ISO		W16	W20		W25			W31,5			W40		W50		W63	
β (°)	26	26	26	26	26	26	26	26	30	30	30	30	30	30	30	30
working temperature	-30°C / +90°C															
relevant standards	ISO 1604 (for W... type only)															
relevant antistatic standard	ISO 1813															
materials	CR blend - polyester cord															

Varisect belts are designed for variable speed transmissions, to obtain a wide range of driven speeds:

- provides exact speed control;
- guarantees smooth running;
- raw edge sidewalls improve gripping action;
- provide superior resistance to aging caused by wear, oil, heat, grease and harmful environmental factors;
- static dissipating;
- is available in a wide selection of sizes;
- guarantees a long belt life.

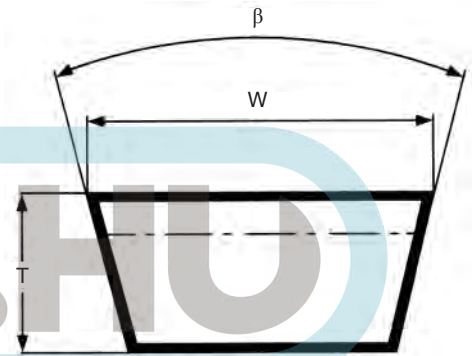

High-modulus cords

Located in the strength section to carry high HP loads with minimum belt stretch. Resists fatigue and shock. Provides excellent belt stability. Reduces need for take-up adjustments.

Fabric tension section

Stretches up to 175% more than ordinary bias-cut fabric to significantly improve belt flex life.

Special compound compression section

Provides uniform cord support and cross-wise rigidity to lengthen belt life.

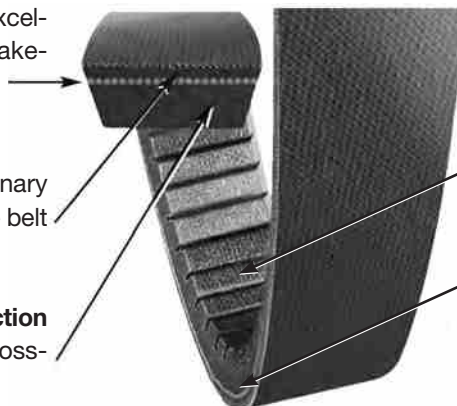

Precision molded cogs

Provide more surface area for heat dissipation and increase belt flexibility. Cooler operation means longer flex life.

Raw-edge sidewalls

Improve gripping contact with pulley sidewalls. Assure less vibration. Smoother, quieter performance.

VARIABLE SPEED V-BELTS

Varisect

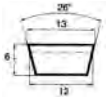

13X6 SECTION

Code	Nominal Pitch length LD (mm)	Code	Nominal Pitch length LD (mm)	Code	Nominal Pitch length LD (mm)	Code	Nominal Pitch length LD (mm)	Code	Nominal Pitch length LD (mm)	Code	Nominal Pitch length LD (mm)
13x6x425	425	13x6x525	525	13x6x650	650	13x6x700	700	13x6x750	750	13x6x900	900
13x6x500	500	13x6x555	550	13x6x675	675	13x6x725	725	13x6x775	775		

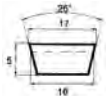

17X6 W16 SECTION

Code	Nominal Pitch length LD (mm)	Code	Nominal Pitch length LD (mm)	Code	Nominal Pitch length LD (mm)	Code	Nominal Pitch length LD (mm)	Code	Nominal Pitch length LD (mm)
16 W 450	450	16 W 560	560	16 W 630	630	16 W 800	800	16 W 1000	1000
16 W 500	500	16 W 600	600	16 W 710	710	16 W 900	900		

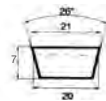

21X7 W20 SECTION

Code	Nominal Pitch length LD (mm)	Code	Nominal Pitch length LD (mm)	Code	Nominal Pitch length LD (mm)	Code	Nominal Pitch length LD (mm)	Code	Nominal Pitch length LD (mm)
20 W 560	560	20 W 640	640	20 W 800	800	20 W 1000	1000	20 W 1250	1250
20 W 630	630	20 W 710	710	20 W 900	900	20 W 1120	1120		

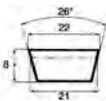

22X8 SECTION

Code	Nominal Pitch length LD (mm)	Code	Nominal Pitch length LD (mm)	Code	Nominal Pitch length LD (mm)	Code	Nominal Pitch length LD (mm)	Code	Nominal Pitch length LD (mm)	Code	Nominal Pitch length LD (mm)	Code	Nominal Pitch length LD (mm)
22X8 X500	500	22X8 X600	600	22X8 X675	675	22X8 X800	800	22X8 X1000	1000	22X8 X1250	1250	22X8 X1600	1600
22X8 X525	525	22X8 X610	610	22X8 X700	700	22X8 X850	850	22X8 X1060	1060	22X8 X1320	1320	22X8 X2000	2000
22X8 X550	550	22X8 X625	625	22X8 X725	725	22X8 X900	900	22X8 X1120	1120	22X8 X1400	1400		
22X8 X575	575	22X8 X650	650	22X8 X750	750	22X8 X950	950	22X8 X1180	1180	22X8 X1500	1500		

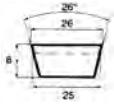

26X8 W25 SECTION

Code	Nominal Pitch length LD (mm)	Code	Nominal Pitch length LD (mm)	Code	Nominal Pitch length LD (mm)	Code	Nominal Pitch length LD (mm)	Code	Nominal Pitch length LD (mm)	Code	Nominal Pitch length LD (mm)
25 W 560	560	25 W 710	710	25 W 790	790	25 W 900	900	25 W 1120	1120	25 W 1400	1400
25 W 690	690	25 W 750	750	25 W 800	800	25 W 1000	1000	25 W 1250	1250	25 W 1600	1613

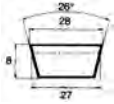

28X8 SECTION

Code	Nominal Pitch length LD (mm)	Code	Nominal Pitch length LD (mm)	Code	Nominal Pitch length LD (mm)	Code	Nominal Pitch length LD (mm)	Code	Nominal Pitch length LD (mm)	Code	Nominal Pitch length LD (mm)	Code	Nominal Pitch length LD (mm)
28X8 X525	525	28X8 X650	650	28X8 X800	800	28X8 X950	950	28X8 X1120	1120	28X8 X1320	1320	28X8 X1600	1600
28X8 X600	600	28X8 X700	700	28X8 X850	850	28X8 X1000	1000	28X8 X1180	1180	28X8 X1400	1400	28X8 X1700	1700
28X8 X625	625	28X8 X750	750	28X8 X900	900	28X8 X1060	1060	28X8 X1250	1250	28X8 X1500	1500		



30X10 SECTION

Code	Nominal Pitch length LD (mm)	Code	Nominal Pitch length LD (mm)	Code	Nominal Pitch length LD (mm)	Code	Nominal Pitch length LD (mm)	Code	Nominal Pitch length LD (mm)	Code	Nominal Pitch length LD (mm)
30X10X650	650	30X10X800	800	30X10X900	900	30X10X1035	1035	30X10X1200	1200	30X10X1500	1500
30X10X665	665	30X10X850	850	30X10X950	950	30X10X1050	1050	30X10X1320	1320	30X10X1600	1600
30X10X700	700	30X10X875	875	30X10X1000	1000	30X10X1120	1120	30X10X1340	1340		

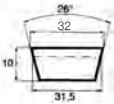

32X10 W31,5 SECTION

Code	Nominal Pitch length LD (mm)	Code	Nominal Pitch length LD (mm)	Code	Nominal Pitch length LD (mm)	Code	Nominal Pitch length LD (mm)	Code	Nominal Pitch length LD (mm)	Code	Nominal Pitch length LD (mm)	Code	Nominal Pitch length LD (mm)
31,5 W 800	800	31,5 W 870	870	31,5 W 950	950	31,5 W 1050	1050	31,5 W 1250	1250	31,5 W 1600	1600	31,5 W 2000	2000
31,5 W 840	840	31,5 W 900	900	31,5 W 1000	1000	31,5 W 1120	1120	31,5 W 1400	1400	31,5 W 1800	1800		

VARIABLE SPEED V-BELTS

Varisect

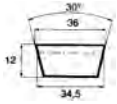

36X12 SECTION

Code	Nominal Pitch length LD (mm)	Code	Nominal Pitch length LD (mm)	Code	Nominal Pitch length LD (mm)	Code	Nominal Pitch length LD (mm)	Code	Nominal Pitch length LD (mm)	Code	Nominal Pitch length LD (mm)
36X12X700	700	36X12X850	850	36X12X1000	1000	36X12X1180	1180	36X12X1400	1400	36X12X1700	1700
36X12X725	725	36X12X900	900	36X12X1060	1060	36X12X1250	1250	36X12X1500	1500	6X12X1800	1800
36X12X800	800	36X12X950	950	36X12X1120	1120	6X12X1320	1320	36X12X1600	1600	6X12X2000	2000

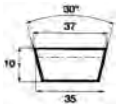

37X10 SECTION

Code	Nominal Pitch length LD (mm)	Code	Nominal Pitch length LD (mm)	Code	Nominal Pitch length LD (mm)	Code	Nominal Pitch length LD (mm)	Code	Nominal Pitch length LD (mm)	Code	Nominal Pitch length LD (mm)
37X10X600	600	37X10X800	800	37X10X1000	1000	37X10X1250	1250	37X10X1600	1600	37X10X2000	2000
37X10X650	650	37X10X850	850	37X10X1060	1060	37X10X1320	1320	37X10X1700	1700	37X10X2240	2240
37X10X675	675	37X10X900	900	37X10X1120	1120	37X10X1400	1400	37X10X1800	1800		
37X10X750	750	37X10X950	950	37X10X1180	1180	37X10X1500	1500	37X10X1900	1900		

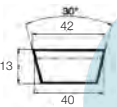

42X13 W40 SECTION

Code	Nominal Pitch length LD (mm)	Code	Nominal Pitch length LD (mm)	Code	Nominal Pitch length LD (mm)	Code	Nominal Pitch length LD (mm)
40 W 1060	1060	40 W 1180	1180	40 W 1600	1600	40 W 2000	2000
40 W 1100	1100	40 W 1250	1250	40 W 1660	1660	40 W 2240	2240
40 W 1120	1120	40 W 1400	1400	40 W 1800	1820	40 W 2500	2500

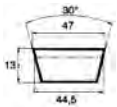

47X13 SECTION

Code	Nominal Pitch length LD (mm)	Code	Nominal Pitch length LD (mm)	Code	Nominal Pitch length LD (mm)	Code	Nominal Pitch length LD (mm)	Code	Nominal Pitch length LD (mm)	Code	Nominal Pitch length LD (mm)
47X13X900	900	47X13X1060	1060	47X13X1250	1250	47X13X1500	1500	47X13X1800	1800	47X13X2240	2240
47X13X950	950	47X13X1120	1120	47X13X1320	1320	47X13X1600	1600	47X13X1900	1900		
47X13X1000	1000	47X13X1180	1180	47X13X1400	1400	47X13X1700	1700	47X13X2000	2000		

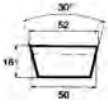

52X16 W50 SECTION

Code	Nominal Pitch length LD (mm)	Code	Nominal Pitch length LD (mm)	Code	Nominal Pitch length LD (mm)	Code	Nominal Pitch length LD (mm)	Code	Nominal Pitch length LD (mm)
50 W 1250	1250	50 W 1600	1600	50 W 2000	2000	50 W 2500	2500	50 W 3150	3150
50 W 1400	1400	50 W 1800	1800	50 W 2240	2240	50 W 2800	2800		

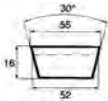

55X16 SECTION

Code	Nominal Pitch length LD (mm)	Code	Nominal Pitch length LD (mm)	Code	Nominal Pitch length LD (mm)	Code	Nominal Pitch length LD (mm)
55X16X1180	1180	55X16X1400	1400	55X16X1700	1700	55X16X2000	2000
55X16X1250	1250	55X16X1600	1600	55X16X1800	1800	55X16X2240	2240

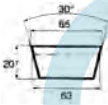

65X20 W63 SECTION

Code	Nominal Pitch length LD (mm)	Code	Nominal Pitch length LD (mm)	Code	Nominal Pitch length LD (mm)	Code	Nominal Pitch length LD (mm)	Code	Nominal Pitch length LD (mm)
63 W 1600	1600	63 W 2000	2000	63 W 2500	2500	63 W 3150	3150	63 W 4000	4000
63 W 1800	1800	63 W 2240	2240	63 W 2800	2800	63 W 3550	3550		

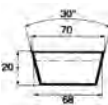

70X20 SECTION

Code	Nominal Pitch length LD (mm)	Code	Nominal Pitch length LD (mm)	Code	Nominal Pitch length LD (mm)	Code	Nominal Pitch length LD (mm)	Code	Nominal Pitch length LD (mm)	Code	Nominal Pitch length LD (mm)	Code	Nominal Pitch length LD (mm)
70X20X1320	1320	70X20X1445	1445	70X20X1600	1600	70X20X1800	1800	70X20X2000	2000	70X20X2240	2240	70X20X2500	2500
70X20X1400	1400	70X20X1500	1500	70X20X1700	1700	70X20X1900	1900	70X20X2120	2120	70X20X2360	2360	70X20X2800	2800